



Athletic Specialties

2023

BASEBALL

SOFTBALL

FOOTBALL

TRAINING

TRACK

SOCCER

LACROSSE

BASKETBALL

LOCKER ROOM

FIELD

MAINTENANCE

800.779.0990

www.asisports.com



My Account Number Is:

ATHLETIC SPECIALTIES

incorporated



We are happy to present the 2023 Athletic Specialties catalog. We work hard to exceed your expectations of quality products and outstanding service. Our knowledgeable sales team is always ready to answer your questions or help you with an order.

Phone: 800-779-0990 • Fax: 800-493-2565 • email: kristi@asisports.com • www.asisports.com



Table of Contents

Field Paint	3	Locker Room	
Field Paint strippers	20	Equipment storage	30
Baseball / Softball		Towels	36
Batting tees	4	Laundry bags/ loops	50
Training sticks	4	Ball storage	43,47
Safety bases	5	Trainers tape	55
Pro Bases	6	First aid	55
Base accessories	6	Wrestling	
Throw down bases	7	Mat tape	36
Pitchers rubbers	8	Mat straps	37
Home plates	8	Volleyball	
Belts	9	Knee pads	37
Line up cards	9	Ref flags	37
Buckets	9	Standards	37
Player accessories	9,14	Track and field	
Protective screens	10 – 11	Shot put / discuss	38
Ball storage	11	Replacement spikes	38
Fielder's masks	11	Starters blocks	38
Training balls	12	Hurdles	38
Ball Dry	30	Pennant flags	40
Umpire items	13	Starters pistols	41
Equipment bags	15	Starters blank	41
Field Maintenance	16 – 17	Megaphone	41
Field Drags	18	Judges stands	41
Field lining sets	18 – 19	Agility training	
Dry Line markers	19	Football	35
Football		Jump ropes	44
Mouth Guards	21	Weight belts	44
QB towels	21	Ladders	46
Cleats and Eye shield	21	Cones	48
Protective pads	22 – 23	Basketball	
Belts	23	Nets	42
Pant laces	22	Rims	42
Hand warmers	22	Accessories	42,43
Chin straps	24 – 25	Storage	43
Jaw pads	25	Soccer	
Helmet Hardware	26	Linesman flag	48
Shoulder pad hardware	27	Shin guards	48
Field repair kits	27	Corner flags	48
Flag football	28	Equipment Bags	49,50
Sideline vests	28	Pumps and Inflators	51
Scrimmage vests	29	Whistles	52
Helmet covers	29	Scorebooks	52
Kicking tees	31	Stadium / Gym equipment	
Field dummies	32	Stadium seat	54
Sideline markers	32	Score board	54
Chain sets	33	Passion arrow	54
Cleat cleaners	46	Table scorer	37

ATHLETIC AEROSOL PAINTS

AMERI-STRIPE AEROSOL PAINTS are available in 21 colors. With a water-based eco-friendly formula, our paints are safe to use on grass and synthetic turf. For a MVP field experience, try our X-treme white paint that complements our base aerosol products.



X-TREME PAINT

Put your field in the spotlight with our superior white marking paint, *Ameri Stripe X-treme Paint*. This high-definition paint has more optical white brighteners than other brands, providing the brightest paint application on your fields.

- Available in 20 oz. or 24 oz. monster can.
- One-pass coverage while still providing the optimum hide.
- 24 oz. Xtreme Monster cans will only fit the liner 501.
- The monster can creates more efficiencies in your paint application process allowing you to use fewer cans to line your field.

COLOR

X-TREME WHITE

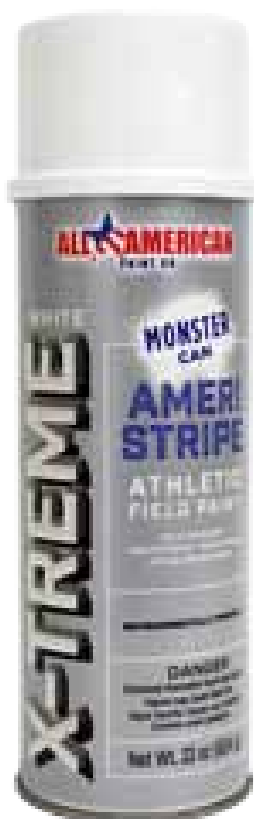

PREMIUM WHITE PAILS

We recommend a 1:1 ration on the first application and on each additional application we recommend up to a 3:1 ratio.

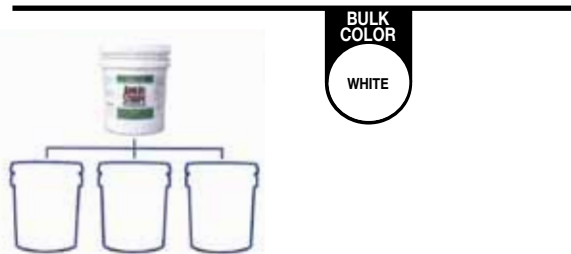

READY2SPRAY WHITE & COLOR PAILS

For white paint, no dilution on first application and on reapplication, up to 1:1 ration. We do not recommend dilution for color paint.



A. Deluxe Batting Tee BBTD

BBTDX
4-Color
Retail Box

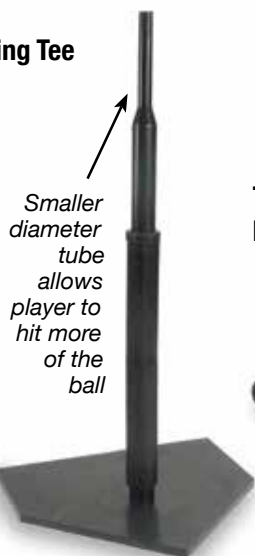

Smaller diameter tube allows player to hit more of the ball

Top Tube BTS2



sleeve inside bottom tube of BBTD & BBT is metal



B. Batting Tee BBT

BBTX
4-Color
Retail Box



Top Tube BTS



New and Improved

C. ASI Pro Tee BTEE

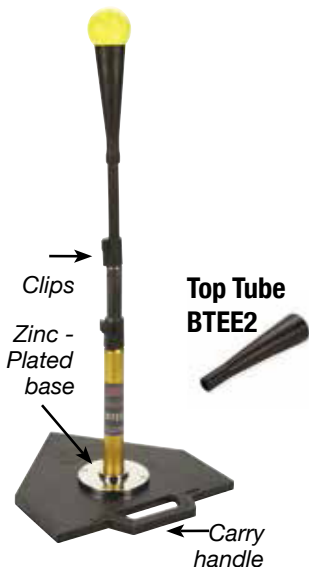

D. Ultimate Travel Tee UTT



Top Tube UTT2

E. Training Stick HNS2

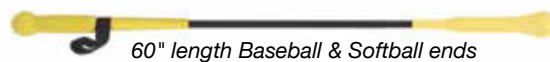

60" length Baseball & Softball ends

F. Baseball Training Bat BTB12

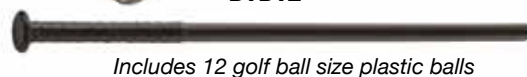

Includes 12 golf ball size plastic balls

G. Hanging Bat Rack HBR



Heavy Duty Steel

Folds Flat

Batting Tees.

A. BBTD - Deluxe Batting Tee. Heavy duty black rubber construction with our new Deluxe Top Tube. Smaller diameter solid rubber tube allows ball to sit higher in tube. This allows player to hit more of the ball and less of the tube. Reduces cracking (breakage) of top tube. Quick height adjustment from 22" to 36". Base tube is reinforced with metal insert to prevent breakage.

BBTDX - BBTD in 4-Color Retail Box.

BTS2 - Replacement Deluxe Top Tube. Smaller diameter solid rubber tube allows player to hit more of the ball. Fits our #BBTD & #BBT batting tees.

B. BBT - Batting Tee. Heavy duty black rubber construction. Quick height adjustment from 22" to 36" for desired height. Base tube is reinforced with metal insert to prevent breakage.

BBTX - BBT in 4-Color Retail Box.

BTS - Replacement Top Tube.

Fits our #BBTD & #BBT batting tees.

C. BTEE - ASI Pro Tee. Made for the elite player. Rubber weighted base with carrying handle. Telescope height adjustment from 23" to 46". Steel shaft screws into zinc-plated base. Top rubber tube folds over, absorbing the impact. **Weighs 12.25 lbs. for stability.** Breaks down for easy travel. Includes tube of glycerine lubricant for top tube.

BTEE2 - Replacement Deluxe Top Tube.

D. UTT - Ultimate Travel Tee. Lightweight, portable and durable for baseball or softball. Metal shaft with top rubber tube that will fold over, absorbing the impact. Base folds with spring-assisted legs. **Folds to fit into standard baseball bat bag.** Height adjusts from 29" to 47". Includes water-resistant carrying bag.

UTT2 - Replacement Top Tube.

Flexible diameter rubber tube allows player to hit more of the ball. Fits # UTT batting tee.

E. Training Stick.

HNS2 - Flexible shaft and features both baseball and softball ends. Ideal training aid. Hand-eye coordination.

F. Baseball Training Bat.

BTB12 - 33 inch, 30 oz. solid black aluminum bat with a 1" barrel with authentic cushioned grip. Increases bat speed and improves hand-eye coordination.

Includes 12 golf ball size plastic balls.

BTB - Bat only.

G. Hanging Bat Rack.

HBR - Powder coated black steel. Holds 10 bats. Hanging hooks fold flat for easy storage.

A. ASI Magnetic Super Base MB1



MB1
Replacement
Parts

B. "Kick-Away" Safety Base Set (with base stakes, anchors & plugs) ABB

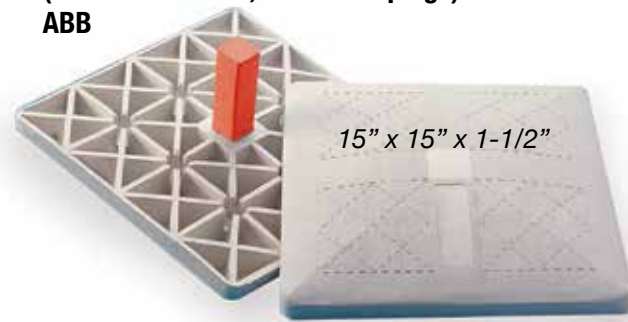

Base Stakes
ASO



Rubber Covered
Ground Anchors
AAO



Base Stake
USO



Ground Anchors
XAO



Anchor Plugs
XPG



C. Premium Double Safety Base FSB

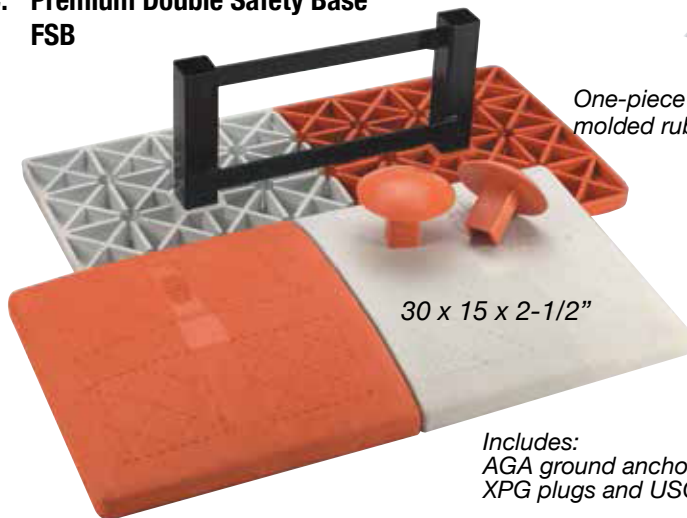

One-piece
molded rubber

30 x 15 x 2-1/2"

Includes:
AGA ground anchor,
XPG plugs and USO base stake.

D. All Rubber Quick Release Safety Base (with base stakes, anchors & plugs) ARSB (individual base) ARSB-3 (set of 3)

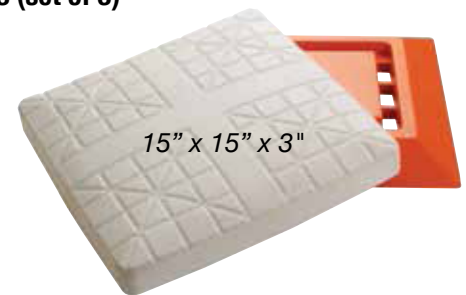

Safety Bases.

A. ASI Magnetic Super Base.

Meets Little League Baseball® rule 1.06 regarding "bases that disengage their anchor".

MB1 - This Magnetic Safety Base Features:

- Designed to "breakaway" on impact from an improper or fast slide, thus preventing severe injury in most cases.
- 1 year warranty on magnetic fixture.
- Ultra durable, rubber moulded base.
- Ribbed design on base prevents slipping.
- 15" x 15" x 3" Base.
- Magnetic Fixture with shear plates for 3 different levels of break force.
- Ground anchor not included.
- Includes: 1 Base with universal steel stanchion, 1 magnetic fixture with shear plates for 3 levels of break force.
- Sold per 1 base only.

• Magnetic Base Replacement Parts.

MBRB - Replacement Base Top.

MBRM - Replacement Mag. Fixture & Shear Plates

B. "Kick-Away" Safety Base Set.

Meets Little League Baseball® rule 1.06 regarding "bases that disengage their anchor".

ABB - The ASO stake allows this base to disengage its XAO anchor system upon a hard slide. 15" x 15" size with sloped side wall that measures 1-1/2" thick to prevent injuries. Includes 3 bases, 3 ASO base stakes, 3 XAO ground anchors and 3 XPG plugs.

Base Anchors & Stakes.

ASO - Solid Rubber Base Stakes for "Kick-Away" action. 5-1/2" x 1-1/2" sq. Sold per each.

AAO - Female Rubber Ground Anchor. 8" x 1-1/2". Sold in set of 3.

XAO - Female Steel Ground Anchor. 8" x 1-1/2". Sold per set of 3.

USO - Solid Rubber Base Stake. 7" x 1-1/2" square. Sold per each.

XPG - Rubber Ground Anchor Plugs. Keeps dirt out of anchors. Sold in set of 3.

C. Premium Double Safety First Base.

Meets Little League Baseball® rule 7.15 regarding "Double First Base".

FSB - One piece molded rubber "Safe Base" in 30" x 15" x 2-1/2" size. Orange portion extends into foul territory for safer play.

Includes AGA ground anchor, 2 USO base stakes and 2 XPG anchor plugs.

D. All Rubber "Kick-Away" Safety Base.

Meets Little League Baseball® rule 1.06 regarding "bases that disengage their anchor".

ARSB - Top base disengages upon impact from Orange bottom base. 15" x 15" x 3" durable, 2-piece rubber molded base. Unique design will not trap/clog dirt. Includes ASO base stake.

Sold per 1 base only.

ARSB-3 - Same as above. Sold per set of 3.

WARNING: ASI advises that sliding into a baseball or softball base represents a clear and present danger. It is the purchaser's responsibility to inform participants of these dangers. Injuries may occur.

A. Anchor Base Set

- HBB (with anchors & plugs)
- HBO (w/o anchors & plugs)
- HPO (metal base only)

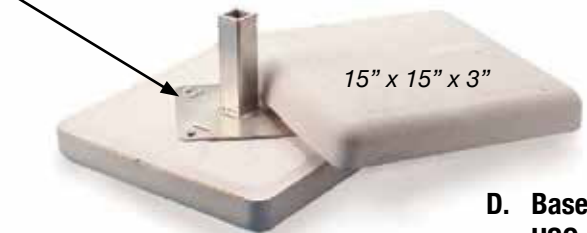

Vinyl/nylon-covered,
foam-filled

15" x 15" x 3"

B. Molded Rubber Safety Base Set

- KBB (with base stakes, anchors & plugs)
- KBO (w/o stakes, anchors & plugs)

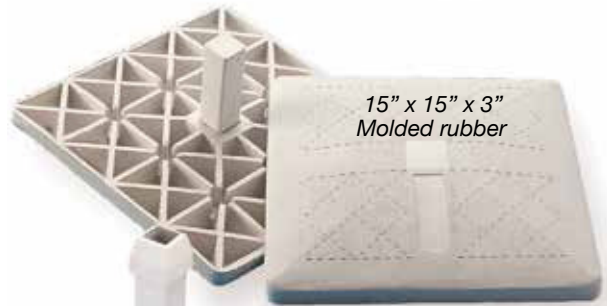

15" x 15" x 3"
Molded rubber

C. Pro Style Base Set

- XBB (with anchors & plugs)
- XBO (w/o anchors & plugs)



15" x 15" x 3"
Rubber-covered,
foam-filled

"No-Bend"
100% welded
stanchion

D. Base Stake USO



E. Ground Anchors XAO

H. Rubber Anchor Plugs XPG



G. Dig Out Tool DOT

I. XPF XPF-3



Foam

Major League Ground Anchor Plugs w/Bristles

U.S. Patent
6,142,882.

J. XPW XPW-3



Rubber

Anchor Bases.

- A. HBB** - 15" x 15" x 3" Anchor Base Set. Bolt-on metal base plate w/universal stanchion. *Includes 3 XAO anchors & 3 XPG plugs.* Set of 3
- HBO** - HBB Bases only. No anchors or plugs.
- HPO** - Replacement metal base plate for HBB.
- B. KBB** - 15" x 15" x 3" Molded Rubber Base Set. *Includes 3 USO rubber base stakes, 3 XAO anchors & 3 XPG plugs.* Sold in set of 3.
- KBO** - KBB Bases only. No anchors or plugs.
- C. XBB** - Top quality "Professional/Hollywood" Base Set. 15" x 15" x 3" regulation size with universal steel stanchion - fits all ground anchors. *Includes 3 XAO ground anchors & 3 XPG anchor plugs.* Set of 3.
- XBB-1** - One XBB Base with anchor & plug.
- XBO** - XBB Bases only. No anchors or plugs.
- XBO-1** - One XBB Base. No anchor or plug.

Base Anchors and Stakes.

- D. USO** - Solid Rubber Base Stake. 7" x 1-1/2" square. Sold per each
- E. XAO** - Steel Ground Anchors. 1-1/2" female opening x 8" length. For all bases/plates that utilize a 1-1/2" anchor system. Sold in set/3.
- F. UBS** - Universal Rubber Base Stake. 1" sq. hollow center for use with 1" sq. male or 1-1/2" sq. female ground anchors. 7" length. Sold per each.
- G. DOT** - Dig Out Tool. Removes loose dirt around ground anchors. Wood handle.

Anchor Plugs.

- H. XPG** - Rubber Ground Anchor Plugs. Keeps dirt out of anchors. Sold in set of 3.
- I. XPF** - Major League Foam Ground Anchor Plugs with Yellow Bristles. Locate anchors quickly. Sold per each.
- XPF-3** - Same as above. Sold per set of 3.
- J. XPW** - Major League Rubber Ground Anchor Plugs with Orange Bristles. Locate anchors quickly. Sold per each.
- XPW-3** - Same as above. Sold per set of 3.

WARNING: ASI advises that sliding into a baseball or softball base represents a clear and present danger. It is the purchaser's responsibility to inform participants of these dangers. Injuries may occur.

A. Heavy Duty Foam Filled Vinyl Base Sets

BB3 - 15" x 15" x 2"

BB2 - 14" x 14" x 2"

BB1 - 15" x 15" x 3"

BB4 - 14" x 14" x 1"

B. Foam Filled Double Safety First Base

FSB2 28" x 14" x 2"

FSB3 - 30" x 15" x 3"

BSI - Web Strap

BGS - Steel Spike

4 Pieces

C. Waffle Bottom Rubber Base Sets

SB10 - Orange

SB1Y - Yellow

SB1 - White

HB20 - Orange

HB2Y - Yellow

Rubber Home Base

HB2W - White

D. Throw-Down Base Sets

5 Pieces

TDSW White
TDSO Orange
TDSH Home Plate

TDSO-4

HBE white
HBE orange

A. Foam Filled Base Sets.

BB1 - 15" x 15" x 3" regulation size. Heavy duty quilted vinyl cover with firm foam filling. Leather reinforced tabs. Water resistant. 2 steel spikes and 2 nylon web straps per base.

BB2 - Same as BB1 in 14" x 14" x 2" youth size.
BB3 - Same as BB1 in 15" x 15" x 2" softball size.
BB4 - 14" x 14" x 1" youth size. Heavy duty nylon cover with foam filling. Water-resistant. Leather tabs and steel spikes. Set of 3.

B. Foam-Filled Double Safety Bases and Replacement Parts.

FSB2 - Heavy duty nylon quilted cover with firm foam filling. 28" x 14" x 2" youth size. Includes 2 steel spikes and 2 nylon web straps.
FSB3 - Same as FSB2 in 30" x 15" x 3" regulation size.
BGS - Replacement Steel Ground Spikes.
BSI - Replacement Nylon Web Straps.

C. Waffle Bottom Rubber Base Sets.

Solid Rubber Base Set with waffle grip bottoms and beveled edges. Set of 3.

SB1 - White
SB10 - Orange
SB1Y - Yellow

Solid Rubber Home Plate with waffle grip bottoms and beveled edges. No spikes.

HB2W - White
HB20 - Orange
HB2Y - Yellow

D. Throw-Down Indoor/Outdoor Bases.

TDSW - 5 Piece Throw Down Base Set. Made of tough, flexible vinyl. Includes: 3 Bases, Home Plate & Pitcher's Plate. **White** .
TDSO - 5 Piece Throw Down Base Set. Orange
TDSO-4 - 4 Piece Throw Down Base Set. No pitcher's plate. **Orange** .
TDSH - Home Plate only. **White** .
HBEW - Home Plate Extension Pad. Makes strike zone more visible in slo-pitch softball. 25-1/2"L x 17"W. **White** .
HBE0 - Same as HBEW, but **Orange** .

WARNING: ASI advises that sliding into a baseball or softball base represents a clear and present danger. It is the purchaser's responsibility to inform participants of these dangers. Injuries may occur.

Baseball - Pitcher's Rubbers & Home Plates

A. Pitcher's Rubbers

4-Way Pitcher's Rubbers
PRX



Step-Down Pitcher's Rubber
PRS



Pitcher's Rubbers w/spikes
PRA



"Pin-Down" Type
PRNA
PRNY

C. Cleat Cleaner
made in USA

RCC - 12" x 11"

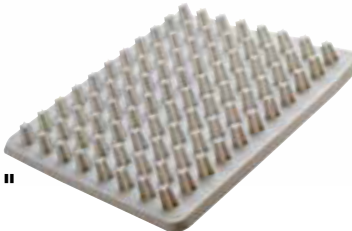

Removable Pitcher's Plate and Anchor

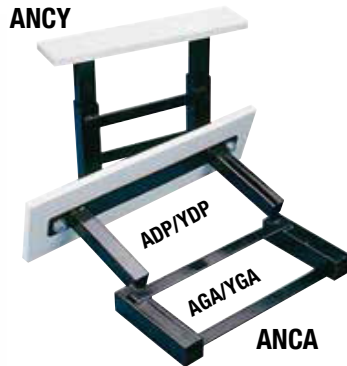

ANPRA Complete Set With #PRA
ANPRL Complete Set With #PRL

Replacement Spikes
SPIKES



Replacement Spikes
screw-in type
RGS

Ground Anchors
XAO



HBX
Waffle Bottom

B. Home Plates

Official Size Rubber Home Plate
HB1



Youth Size Rubber Home Plate
HB2

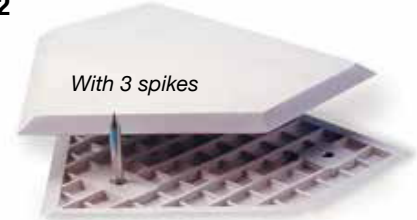

Pro Home Plate
HBPRO-A

With #XAO
Ground Anchor
HBPRO
w/o #XAO Ground Anchor



In-Ground Home Plates
HBXW - Wood Bottom



A. Pitcher's Rubbers.

PRX - Regulation size: 6" x 24".
PRX2 - Youth size: 4" x 18".

Step Down Pitcher's Plates.

PRS - Regulation size: 6" x 24".
PRS2 - Youth size: 4" x 18".

Pitcher's Plates With 3 Removable Spikes.

PRA - Regulation size: 6" x 24" x 3/4".
PRL - Youth size: 4" x 18" x 3/4".

"Pin-Down" Pitcher's Plates With 2 Spikes.
Spikes go through steel plates embedded in rubber.

PRNA - Regulation size: 6" x 24" x 3/4".
PRNY - Youth size: 4" x 18" x 3/4".

SPIKES - Replacement Spikes for #PRNA & #PRNY. Pack of 4.

Removable Pitcher's Plate and Anchor.

ANCA - Complete 2 piece set of ground anchor and double post which bolts onto bottom of flat pitcher's rubber. Fits regulation #PRA style. *Does not include #PRA.*

ANPRA - 3 piece set as above *includes #PRA.*

ANCY - 2 piece set as above. Fits youth #PRL style. *Does not include #PRL.*

ANPRL - 3 piece set as above *includes #PRL.*

AGA - Ground Anchor (female portion) replacement for #ANCA.

ADP - Double Post (male portion) replacement for #ANCA.

YGA - Ground Anchor (female portion) replacement for #ANCY.

YDP - Double Post (male portion) replacement for #ANCY.

B. Home Plates.

HB1 - Official Size Home Plate with **Black** beveled edges. 5 Removable Spikes.

HB2 - Youth Size Home Plate. Beveled edges with 3 Removable Spikes.

HBPRO-A - Official Home Plate with Pro Style Steel Mounted Stanchion. **Black** beveled edges. *Includes #XAO steel ground anchor.*

HBPRO - Official Home Plate with Pro Style Steel Mounted Stanchion. **Black** beveled edges.

HBX - Official Home Plate - Bury in ground style with waffle bottom. **Black** beveled edges.

HBXW - As above HBX with wood bottom to prevent dirt accumulation in cavities.

RGS - Replacement Screw-In Spikes for home plates (#HB1 & #HB2). Sold per each.

C. Cleat Cleaner.

RCC - Heavy duty throw-down pad has 88 tough rubber bristles to quickly remove debris from bottom of shoes. 12" x 11". Has a hole on each corner for stake-down option. *Used by most Major League Baseball teams!*

WARNING: ASI advises that sliding into a baseball or softball base represents a clear and present danger. It is the purchaser's responsibility to inform participants of these dangers. Injuries may occur.

A. Elastic Baseball Belts

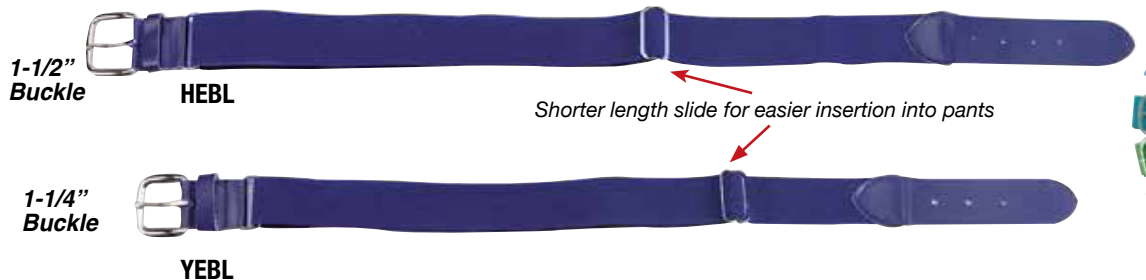

C. Quick Hands Training Mitt

TRG



TRGX
Retail
Packaged

D. Replacement Cleats



H. ASI Baseball Buckets

BUCK
BUCK36



E. Palmguard® Sting-Stopper™

PGI



F. Line Up Cards

LUC25
LUC

Custom
Printing
Available



G. Glove Softener

LOS



with
cushioned
top

Belts.

A. HEBL - 1-1/2" Elastic Belt with matching 1-1/2" leather tab and nickel plated buckle. Features extra slim slide for ease of pulling belt through pant tunnel. Adjusts to fit 22" - 48" waist sizes.

YEBL - Youth 1-1/4" Elastic Belt with matching 1-1/4" leather tab and nickel plated buckle. Features extra slim slide for ease of pulling belt through pant tunnel. Adjusts to fit 18" - 38" waist sizes.

18 Colors: White, Black, Scarlet, Cardinal, Maroon, Purple, Royal, Navy, Columbia Blue, Kelly, Dark Green, Teal, Gold, Orange, Gray/Silver, Graphite, Neon Green & Pink.

**Baseball Scorebooks and Clipboards
Page 51**

B. WLBT - 1-1/2" Leather Belts w/heavy duty stitching and nickel plated buckles and rivets. Sizes: S (28"), M (32"), L (36"), XL (40") and XXL(44"). 10 Colors: Black, Cardinal, Dk. Green, Gold, Maroon, Navy, Orange, Purple, Royal and Scarlet.

C. "Quick Hands" Baseball Training Mitt.

TRG - Fielder's mitt designed for players to learn how to stop & trap balls - especially grounders - with both hands. Slightly concave 8" diameter well padded ball strike area "deadens" the ball & provides an unrestricted area for player to use free hand to trap ball against mitt. Elastic hand & finger loops securely keep mitt in proper position. One size fits all.

TRGX - TRG Retail Packaged.

D. Baseball/Softball Replacement Cleats.

Fits all screw-in shoes. 14 cleats with bolts. Blister packaged.

BRC-M - Metal.

E. Palmguard®.Sting-Stopper™.

PGI - Protective glove insert. Fits both left or right hand.

F. Line-Up Cards. Custom printing available.

LUC - Four part carbonless 8 1/2" x 3 1/2" sets. Spaces for 13 players. Sold per 100/ package.

LUC25 - Same as above. Sold per 25/ package.

G. Glove Leather Softener & Preservative.

Lubricates gloves and leather articles.

LOS - Aerosol 5 oz. cans for easy use. Sold per dozen.

H. ASI Ball Buckets.

BUCK - 6 gal. plastic bucket with cushioned top for seating comfort. 17" High, 12" Diameter. Holds up to 5 doz. baseballs or 2 doz. softballs.

BUCK36 - ASI Ball Bucket with 3 doz. ASI # OLB10 "NFSH Approved" baseballs.

Protective Screens & Backstop Padding

A. Pitcher's L-Shaped Frame and Net PROL LNET (replacement net)



Fungo Protection Frame and Net PROB FNET (replacement net) PROB-FO (replacement frame)

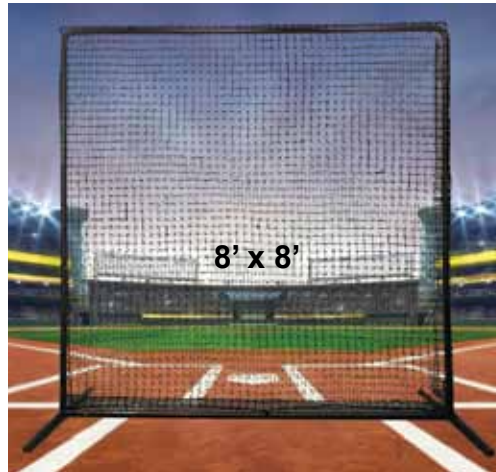

Pitcher's L-Shaped Frame and Net PBL5 BNET (replacement net)



B. Wheel Kit WHEEL



C. Pitcher's Protector Carry Bag LBAG



E. Backstop Padding BSTOP

D. Mini Pro L-Screen w/pneumatic wheels PMLS MLNET (replacement net)



Baseball Protector Frame and Nets.

A. PROL - Pitcher's L-Shaped Protective Frame and Net. This heavy duty 6-1/2' H x 6' W frame features bolt-together frame and legs. The 1-5/8" powder-coated steel tubing provides excellent strength and safety. Tools for assembly included. *Includes our # LNET Net.*

LNET - Knotted L-Shaped Slip-on "Pillow Case" Net. Double-thick 240-lb. breaking strength. Twisted polyethylene, weather treated, **Green** color. Fits other "L" shaped pitcher protectors that measure 6-1/2' H x 6' W.

PROB - Oversize 8'H x 8'W Base/Fungo Protective Frame & Net. Oversize heavy duty square frame features bolt-together frame and legs. The 1-5/8" powder-coated steel tubing provides excellent strength and safety. Wrenches included. *Includes our #FNET Net.*

FNET - First Base/Fungo Protector Net. Double-thick 240-lb. breaking strength. Twisted polyethylene, weather treated, **Green** color. Use on **PROB** Frame or others that measure 8' H x 8' W.

PROB-FO - Replacement Frame.

PBL5 - Deluxe Pitcher's L-Shaped Screen & Net. 7' x 7' Black powder-coated 1-1/2" steel frame with Black heavy-duty weather & U.V. treated pillow-case double thickness net. *Push-button connectors make for easy setup*

BNET – PBL5 Replacement Net. Heavy-duty weather & U.V. treated, twisted pillow-case knotted netting. Fits all "L" shaped 7' x 7' frames. Net is Black color.

B. WHEEL - Protector Wheel Kit. Clamps onto all Protective Frames. Steel axle construction with two 8" wheels.

C. LBAG - Pitcher's Protector Carry Bag. #PROL Frame & Net fit into bag for easy transport. **Black** vinyl/nylon. Measures 54" x 28".

D. Mini Pro L-Screen.

PMLS - Used by the pros! Heavy-duty frame is 7' x 5' and features 2" heavy gauge steel frame w/pillowcase net. Includes pneumatic wheels and heavy-duty fabric wrapped foam that encases the entire frame.

MLNET - PMLS Replacement Net. Heavy-duty weather & U.V. treated, twisted pillow-case knotted netting. Net is Black color.

E. Backstop Padding.

BSTOP - 2" thick padding inside extra tough 18oz. vinyl/nylon cover with tie-on grommets. Specify length & height per ft. and color. Made to order. 2 week delivery. **11 Colors** (see page 14). Priced per sq. ft. Made to order. Non-refundable/Non-returnable.

A. Softball Pitcher's Frame and Net
PROM
MNET (replacement net)
PROF (replacement frame)

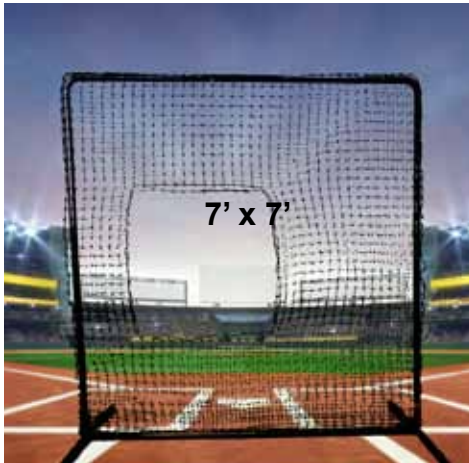

B. Sock Frame and Net
PROC
CNET (replacement net)
PROF (replacement frame)

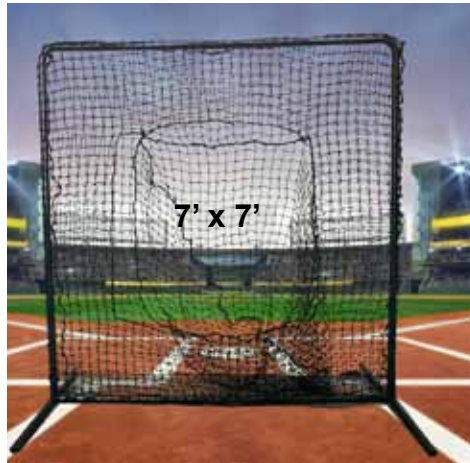

C. Fungo Protection Frame and Net
PBFS
BFNET (replacement net)



D. Steel Mask
GFY
GFA



E. Game Face® Safety Masks
GFM
GFL



F. Pitcher's Ball Carts
PBC



G. Multi-Sport Rebounder
PBR
PBNET (replacement net)



72"H x 42"W

Baseball Protector Frame and Nets.

A. PROM - Softball Pitcher's Frame and Net.

Heavy duty 6-1/2' H x 6' W square frame features bolt-together frame and legs. The 1-5/8" powder-coated steel tubing provides strength and safety. Wrenches included.

Includes our MNET net.

MNET - Softball Pitcher's Protector Net.

Cut-out softball delivery fast pitch and use on pitching machines. Double-thick 240-lb. breaking strength. Twisted polyethylene, weather treated, **Green** color. Use on PROF Frame or others that measure 6-1/2' H x 6' W.

B. PROC - Sock Frame & Net. Suitable for batting drills, pitching drills, and as a football kicking net. Ball falls to bottom "sock" for easy retrieval. Includes our CNET net.

CNET - Double-thick 240-lb. breaking strength. Twisted polyethylene, weather treated, **Green** color. Use on PROF Frame or others that measures 6-1/2' H x 6' W.

PROF - Replacement frame.

C. PBFS - Deluxe 1st Base/Fungo Screen & Net.

7' x 7' Black powder-coated 1-1/2" steel frame with Black heavy-duty weather & U.V. treated pillow-case netting. Push-button connectors make for easy setup. Retailer packaged with UPC barcode.

BFNET - PBFS Replacement Net. Heavy-duty weather & U.V. treated, twisted pillow-case knotted netting. Fits all 7' x 7' frames. Net is Black color.

Batter's Face Guards - Baseball/Softball.

D. Steel Safety Mask.

Solid steel protective cage for softball. Black mask/black padding. One size fits most. **GFY** - Youth, head sizes up to 21-7/8". **GFA** - Adult, head sizes 22" & larger.

E. Game Face® Sports Safety Masks.

Ultra-lightweight, shatter-proof & engineered for full facial protection (eyes/nose/cheek & dental). Vertical and horizontal bars for a custom secure fit. Oversized ports allow unobstructed view. **Clear** Mask/**Black** Padding.

GFM - Medium-Youth, head sizes up to 21-7/8".

GFL - Large-Adult, head sizes 22" & larger.

F. Pitcher's Ball Carts.

PBC - Sturdy 1-1/2" galv. steel frame with 3 height adjustments 24", 30" & 36" with wheels. Large nylon basket with heavy mesh on bottom & 2 sides allows air flow through ventilation. Holds 60 baseballs.

PBC-MESH - Sturdy HD powder coated steel frame with pneumatic wheels. Premium mesh basket. Holds 300 baseballs.

G. Deluxe Multi-Sport Pitchback Rebounder.

PBR - 1-1/4" powder coated steel tubing. Swedged joints with thumb snaps for easy assembly. Adjustable to multiple angles for play on both sides. Heavy duty netting w/ bungee cords and moveable strike zone outline included.

PBNET - Replacement Net.

A. ASI Plastic Balls



B. Total Control Balls™



D. Dimpled Pitching Machine Balls



C. Ball Holders

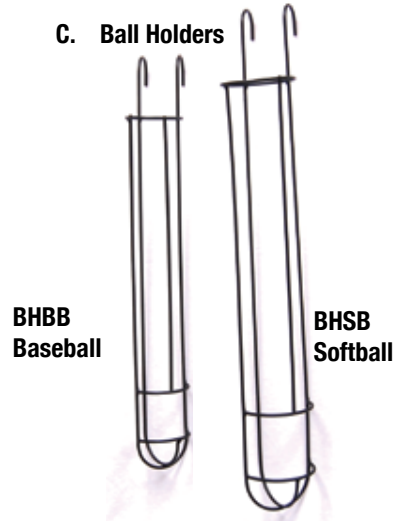

E. Soft Foam Safety Balls



F. Tennis Balls



G. ASI Heavy-Duty Plastic Balls



H. Pickle-Balls®



A. ASI Plastic Balls.

9" Baseball, 12" Softball & Golf Ball size.

BWB1 - Baseball (*White*) - Box of 100.

BWBY1 - Baseball (*Yellow*) - Box of 100.

SWB1 - Softball (*White*) - Box of 100.

SWBY1 - Softball (*Yellow*) - Box of 100.

BWB - Baseball (*White*) - Bag of 12.

BWBY - Baseball (*Yellow*) - Bag of 12.

BWB6 - Baseball (*White*) - Retail bag of 6.

BWBY6 - Baseball (*Yellow*) - Retail bag of 6.

SWB - Softball (*White*) - Bag of 12.

SWBY - Softball (*Yellow*) - Bag of 12.

SWB6 - Softball (*White*) - Retail bag of 6.

SWBY6 - Softball (*Yellow*) - Retail bag of 6.

GFWB5 - Golf Ball (*White*) - Box of 500.

GFWB50 - Golf Ball (*Orange*) - Box of 500.

GFWB - Golf Ball (*White*) - Bag of 12.

GFWBO - Golf Ball (*Orange*) - Bag of 12.

B. Total Control Balls™.

TC82 - 3.2" Diameter. 14.9 oz. Sold per 12.

TC82-6 - 3.2" Diameter. 14.9 oz. *Sold per 6.*

TC82-3 - 3.2" Diameter. 14.9 oz. *Sold per 3.*

TC74 - 2.9" Diameter. 14.9 oz. Sold per 12.

TC74-6 - 2.9" Diameter. 14.9 oz. *Sold per 6.*

TC74-3 - 2.9" Diameter. 14.9 oz. *Sold per 3.*

TC120-6 - 4.7" Diameter. 31.7 oz. *Sold per 6.*

TC120-3 - 4.7" Diameter. 31.7 oz. *Sold per 3.*

TCHB80 - Hole Ball. 3.2" Diameter. 2.8 oz./12.

TCHB74 - Hole Ball. 2.9" Diameter. 2.5 oz./12.

TCGOLF - Golf Ball Size. 0.9 oz. Sold per 12.

C. Ball Holders.

Powder coated black steel. Hangs on fence.

BHBB - Holds 10 baseballs.

BHSB - Holds 9 softballs.

D. Pitching Machine Balls.

Sold per Dozen. Will not damage aluminum bats or sting hitter's hands.

PMSB - 12" Softball size. Dimpled *Yellow*.

PMFB - 11" Softball size. Dimpled *Yellow*.

PMBB - 9" Baseball size. Dimpled *Yellow*.

PMBBW - 9" Baseball size. Dimpled *White*.

E. Soft Foam Safety Balls w/Realistic Seams.

Sponge-like texture makes them safe for indoor hitting. Players will not get stung by the ball if it hits off arms or body. Sold per dozen.

SFSB - 12" Softball size. *Yellow*.

SFBB - 9" Baseball size. *White*.

F. Tennis Balls.

TB12 - Great for Baseball or Tennis Practice. Sold per dozen.

G. ASI Heavy Duty Plastic Balls.

Thicker wall construction for increased durability. Will last longer than other regular plastic balls. Hole pattern provides truer flight. For pitching machine use & soft-toss drills.

HDB - 9" Baseball Size. Bag of 12. *Neon Green*.

HDB1 - 9" Baseball Size. Box of 100. *Neon Green*.

HPB - 9" Baseball Size. Bag of 12. *Yellow/Black*.

HPB1 - 9" Baseball Size. Bag of 12. *Yellow/Black*.

HDS - 12" Softball Size. Bag of 12. *Neon Green*.

HDS84 - 12" Softball Size. Box of 84. *Neon Green*.

H. Pickle-Balls®.

Plastic baseball that has a thicker wall structure for increased durability. Rotationally molded ball (one-piece) is slightly heavier than other plastic balls. Does not split or crack. Hole pattern provides truer flight. For pitching machine use & soft-toss drills. *Yellow & Neon Green*.

Bag of 12. **PB12-Y** **PB12-N**

Box of 60. **PB60-Y** **PB60-N**

A. Umpire Indicators



UM3



UM4



UM7



UM5

B. Umpire Brush UMB



C. Umpire Combo Set USET



D. Umpire Ball Bags

UMC-BK (black)
UMC-N (navy)



E. Throat Guards

BTGY (4-1/2" youth)
BTGA (6-1/2" adult)



F. Leg Guard Straps RLS



G. Hand Tally Counter HTC



H. OSLO® All Purpose Stopwatch STPO



I. Faceguard Mounting Hardware Set FGBH



J. Baseball & Hockey Face Mask Buckle SSBH

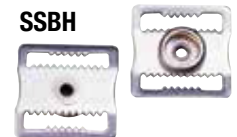

A. Umpire Indicators. Blister packaged.
UM3 - Heavy duty **Black** plastic - 3 wheel model counts balls, strikes, & outs. Sold per doz.

UM4 - As above but 4-wheel model also counts innings. Sold per dozen.

UM7 - 3 Wheel Indicator in sturdy stainless steel. Blister carded. Sold per each.

UM5 - Oversize Umpire Indicator has large easy to read numerals and it molds comfortably into left hand for extra ease of wheel operation. Top window shows "balls" to counts of 0,1,2,3,4. Middle window shows "strikes" to count of 0,1,2,3. Bottom window shows "outs" to counts of 0,1,2,3. Sold per each.

B. Umpire Plate Brush.

UMB - Contoured wooden handle and durable bristles. Blister packaged.

C. Umpire Combo Set. USET - Includes ball bag, plate brush & 4-way indicator. Retail packaged.

D. Umpire Ball Bag. Nylon construction, holds 6 balls, indicator and plate brush. Fits on belt.

UMC-BK - Black. UMC-N - Navy.

E. Throat Guards. High Impact Throat Guards. **Black only.** Hard poly molded with Velcro straps for secure fit. Youth - 4-1/2", Adult - 6-1/2".

BTGA - Adult size.

BTGY - Youth size.

F. Leg Guard Replacement Straps.

RLS - Black elastic straps and hooks for all leg guards. Bag of 12.

G. HTC - Hand Tally Counter.

All purpose counter in chrome finish. 4 digits w/ finger ring. Resets to zero with easy turn knob. Great for counting pitches, attendance, lap, etc.

H. OSLO® Stop Watch with Lanyard.

STPO - Basic stopwatch to 24 hr., 1/100 sec. for 30 min. Cumulative splits. Calendar, time & alarm. Large easy to use buttons.

I. Helmet Hardware. FGBH - Set of Hardware and Straps to mount face guards to batting helmet in 3 places. Includes: 3 ea. t-nut, screws & straps.

CLS - Black plastic straps only for mounting wire style batting helmet face guards.

TNS - Short T-Nut (1/8").

CHB - Combo Head Screw (1/2"), **Black.**

J. Baseball & Hockey Face Mask Buckle.

SSBH - Steel buckle with 1" wide slots.

A. Glove Relacing Leather 2 Sizes, 3 Colors



GKN
U-Shaped
Pull-thru
Needle

GRK



D. Catcher's Knee Support KSA (adult) KSY (youth)



B. Weather Tarps

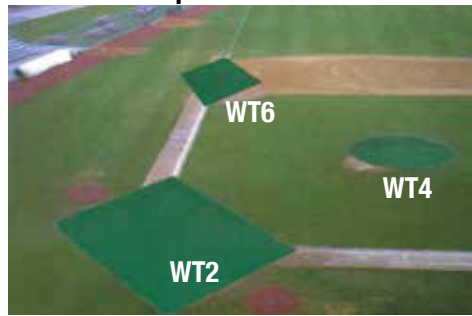

C. Bat Weight BAWT



E. Batting Helmet Chinstraps

BHS
BHS-SSB
BHSR



F. Glove Softener LOS



G. Eye Black Combo EB-COMBO

**18 Pairs
Eye Black
Stickers/
Grease Tube
Combo Pack**



H. Rosin Bag RBC



I. Eyeglass Holders EGH



A. Heavy Duty Glove Relacing Leather.

Sold per each.
HGL - 3/16" wide x 60" long. (Most popular size) **Tan, Brown, or Black.**
HGW - 1/4" wide x 60" long.
Tan, Brown or Black.
GRK - Glove Repair Kit. One GKN pull- through needle & 3/16" **Tan** lace in poly bag.
GKN - "U" shaped pull through needle.

B. Weather Tarps.

WT2 - Weather Tarp for home plate area is 26' square. Material is reinforced 14 oz. vinyl impregnated nylon with grommets every 3' around perimeter. Includes ground stakes. Color: **Green** on top & **Gold** on bottom.
WT4 - Weather Tarp for pitchers mound area measures 20' in diameter. Other specifications as above.
WT6 - Set of 3 Weather Tarps for first, second & third base areas measure 10' square each. Other specifications as above.

C. Bat Weight.

BAWT - Safety rubber tube slips on and off like a doughnut. Tapered sleeve prevents it from coming off bat. Has better weight distribution on the sweet spot. Will not scratch bat. Weights 20 ozs. **Royal Blue.**

E. Batting Helmet Chin Straps.

BHS - Black 3/4" Elastic Straps are sturdy yet soft against chin area. Plastic buckles. Bag of 12.
BHS-SSB - Same as above but with Steel buckles.
BHSR - BHS strap retail packaged.

F. Glove Leather Softener & Preservative.

Lubricates gloves and leather articles.
LOS - Aerosol 5 oz. cans for easy use. Sold per dozen.

D. Athletic Specialties' Knee Support Pads.

Minimize strain by cushioning the knee joint. Wedge shape fits behind knee and attaches to straps on catcher's leg guards.
4 Colors: Black, Navy, Scarlet, & Royal.
KSY - Youth size. Fits 5'7" tall & under.
KSA - Adult size. Fits 5'8" tall & up.

G. Eye Black Stickers & Grease Combo Pack.

EB-COMBO - Includes 18 pairs of Eye Black's solid black original product and 1 tube of Eye Black Grease. Simply smear grease on and create any shape you want. Retail Packaged.

H. RBC - Rosin Bag.

Blister packaged. Sold per each.

I. Eyeglass Holders.

EGH - Sports style Black elastic strap with end-loops is fully adjustable to fit all glasses. Retail blister packaged. Sold per dozen.

**A. Helmet Fence Bag
BHR**



**Hanging Bat Bag
BBR**



**B. Combo Helmet/Bat Bag
BCR**



C. Canvas Duffel Bags



D. Extra-Long Equipment Bag



E. Large Equipment Bag

LEB Full top-opening zipper



**F. Deluxe Equipment Bag
ST65**



Screen print available.

G. Ball Bags

Stand-up lat bottom



Bat Bag



A. BHR - Batting Helmet Rack/Bags.

Heavy duty reinforced 420 denier vinyl coated nylon. Hangs on fencing, holds 8 helmets with face guards. Carrying handles. USA Made.
7 Colors listed below.

BBR - Bat Rack/Bags. Heavy duty reinforced 420 denier vinyl coated nylon. Hangs on fencing, holds 9 bats & folds up with bats inside. Carrying handles. USA Made.
7 Colors listed below.

B. BCR - Combination Helmet/Bat Rack Bags. Heavy duty reinforced 420 denier vinyl coated nylon. Holds 6 bats, 4 batting helmets plus extra pocket in center for more helmets or misc. gear. Folds up with carrying handles. USA Made.
7 Colors listed below.

C. Canvas Duffel Bags. USA Made.

PDB - Extra wide duffel bag with draw cord and lace-lock is 24" x 42". Durable canvas with extra bottom attached. Inside pocket and shoulder strap. Holds set of football equipment, baseball gear, etc. Bottom colors: Black, Navy, Royal & Red.

SDB - 10 oz. light weight natural flat canvas bag is 22" x 34". Shoulder strap with draw cord & lace lock.

D. Extra-Long Equipment Bags. USA Made.
XEB - 34" x 15" x 12". Long enough for bats & wide enough for bases. Convenient baseball size bag with tough full opening zipper and D-rings on each end.
7 Colors listed below.

E. Large Equipment Bags.
LEB - 26"L x 14"W x 16"H. Easily holds complete set of baseball gear. Large 3 cu.ft. for team catcher's gear or batting helmets & miscellaneous equipment. USA Made.
7 Colors listed below.

F. Deluxe Equipment Bags.

ST65 - 36" L x 18" W x 16" H. Heavy-duty polyester, water resistant fabric with a PVC backing. Rubberized bottom for added strength. U-shaped zippered opening. 2 end zippered pockets with interior zipped pockets. 45" handles for easy carrying. Padded hand grip.
7 Colors: Listed below.

G. Deluxe Ball Bags. USA Made.

BAD - Heavy duty vinyl coated nylon with zipper top and carrying handles. Holds 3 dozen balls.
7 Colors listed below.

BAL - Baseball Bags. Draw cord closure, carrying handles, holds 3 doz. balls. USA Made.
7 Colors listed below.

BAT - Bat Bags. Draw cord closure, carrying handles, holds 1 doz. bats. USA Made.
7 Colors listed below.

Color List: Scarlet, Royal, Dark Green, Navy, Black, Maroon, & Purple.



Pro-Lute

- Pro groundskeeper quality infield maintenance tool
 - Much lighter than traditional rakes/lutes
 - Magnesium blades are much stronger and lighter than aluminum
 - Extra long 6' handle and light weight
 - Blade features sharp teeth on one side and a leveling edge on the other side
 - Also doubles as a tamper
 - Replacement parts are available
- 36" Lute Rake #03704 - 4 lbs.**



Field Rakes

- HD aluminum handle and head with large teeth on one side, and a rugged leveling blade on the other
- 36" RK3 - 5 lbs.**



Scarifier/Lute

- HD aluminum handle and 36" head
 - Pointed scarifying teeth offer more effective digging than most blunt tooth lute rakes
 - Larger leveling blade on other side
- SCLF - 5 lbs.**

Professional Drag Brooms

- Lightweight, easy to use grooming tools can be pulled or pushed, creating a manicured professional appearance
- Dual action design can be used bristle side down to finish drag your field with minimal material buildup, or turn handle over and pull from the opposite direction to utilize the 7' wide cutting edge
- Standard model features a straight cutting and leveling edge for shaving down high spots and filling in low areas
- Double play model features a row of pointed scarifying teeth for breaking up hard, compacted infields
- Both models measure 7' wide and feature an all-aluminum construction with 2 rows of durable, 4 1/2" long poly bristles, a 4' fluted A-frame handle with 18" wide cushion grip, and 2 hooks for hanging

Standard Drag Broom w/ Straight Edge
DBSE - 15 lbs.

Double Play Drag Broom w/ Scarifying Teeth
DPST - 17 lbs.



Base Runner Telescopic Rake

- Brings a new level of portability to infield maintenance
 - Compact it fits in the trunk of a car, yet is tough enough for the most demanding use
 - Handle telescopes down to 39" and the 36" wide rake head is easily removed
 - Rake head features a leveling blade on one side and a leveling blade on the other
- Baserunner - 6 lbs.**



Double Play Grooming Rake

- One side features a row of short, pointed scarifier teeth, while the other side sports longer landscaping teeth
 - HD all-aluminum 66" handle with wrap-around braces and a 36" wide head
- DPGR - 6 lbs.**



Double Play Finishing Broom

- Brush is excellent for finishing work and sweeping infield material from the turf perimeter; flip the head and you have a row of scarifier teeth for infield prep
 - HD 60" aluminum handle w/ 28" wide head
- DPFB - 6 lbs.**



Screening Rake

- HD aluminum handle and 36" head
 - Specially designed "S" teeth are ideal for sifting and screening stones and debris
 - Other side has small leveling edge
- SRAKE - 6 lbs.**



Level Head Rake

- Great lightweight multi-purpose rake
 - Steel head measures 17" wide and has a 60" powder-coated aluminum handle
- LHR - 4 lbs.**



Infield Lip Broom

- Aluminum handle braced to a 24" head, which has poly bristles for light to aggressive sweeping
 - Great for sweeping infield material out of the turf and general cleaning
- LIP - 6 lbs.**



Field Prep Package

- Buy this package and save
 - Kit includes (1) 36" field rake, (1) dirt tamp, (1) 2-way hoe, and (1) 7' pro drag broom
- #PREP1K - 50 lbs.**



Loop/2-Way Hoe

- Dual action hoe cuts grass and weeds out by the roots with minimal surface disruption
- Great for base paths
- HD stamped steel head with aluminum handle

LOOP2 - 4 lbs.



Sand Comb

- Prevents sliding injuries from debris
- Quickly and effectively sifts debris from sand and soil
- Cast aluminum with a 1/4" mesh screen
- 16"W x 4"H catch
- Replacement screens available

SC16 / 7 lbs.



Pro Edger & Sod Cutter

- Rugged kick-type edger and sod cutter produces sharp, uniform lines on your infield turf perimeter
- Cuts uniform 12" strips of sod quickly and smoothly
- You can average 30' of sod in 60 seconds and trim edge lines even faster
- HD construction features a one-piece steel frame, self-lubricating nylon bearings, hardwood handles, and a tempered, fully adjustable blade with a sharp edge

12" - **EDGE** / 27 lbs.



Cocoa Mop



Flex Steel Mop



Finishing Mops

- Designed for those small areas that are nearly impossible to finish grooming
- Great for mounds, infield edges, base paths, on-deck circles, and any other cutouts
- 24"W x 18"D mats are available in your choice of either a high quality cocoa mat or a heavy-duty flexible steel mat
- The 66" handles and attachments are constructed from HD reinforced aluminum
- Replacement mop heads available

Cocoa - **CMOP** / 12 lbs.

Flex Steel - **EMOP** / 12 lbs.

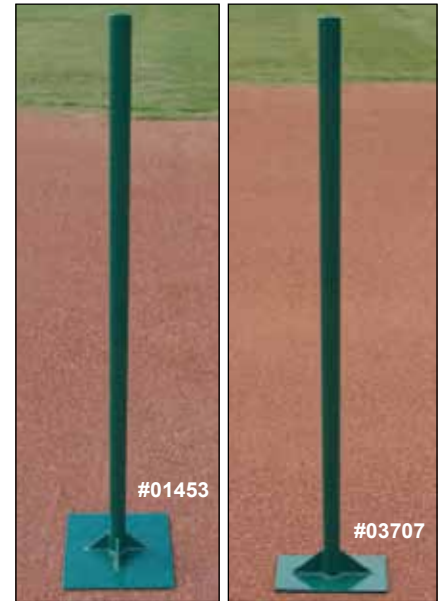

#01453

#03707

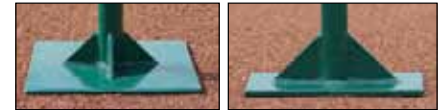

Pro Series Dirt Tamps & Socks

- HD tamps designed for a lifetime of use
- Welded all steel construction w/thick base plates, 1 1/2" dia., 48"L heavy wall handle
- Large welded gusset braces for maximum durability and a powder-coated finish
- Finishing size is great for around the pitching rubber and mound
- Tamp Socks keep dirt from sticking
- Socks are 3-ply denim for extra durability

Tamps

10" x 10" Pro (1/4" Thick Base)

TMP / 17 lbs.

Tamp Socks

10" x 10" - **TMPS** / 1 lb.

Scoop Sifting Shovel

- 14" x 17" scoop is perfect for sifting and removing debris when top dressing athletic fields
- Works with sand and all types of soil
- HD, yet lightweight, one piece molded poly with a 27" D-grip handle.

SSFS / 3 lbs.



Sifting Shovels

- Sift debris and stones from infield materials, dig out leaking irrigation wells, and shovel wet, muddy materials
- Heavy 14 gauge steel heads with 48"L solid core fiberglass handles

Square Point

SPS / 5 lbs.

Round Point

RPS / 5 lbs.



E-Z Reacher

- Easily picks up objects as delicate as flower petals or as large as a 5 lb. rock
- Rubber cups on the pick-up end that squeeze together to conform to the object

48" Model - **EZ48** / 3 lbs.

A. Steel Drags Field Drags



B. Cocoa Mat Drags

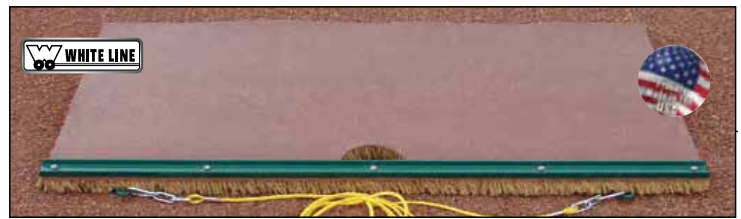

C. Standard Steel Templates



D. 3-Way Adjustable Batter's Box Template

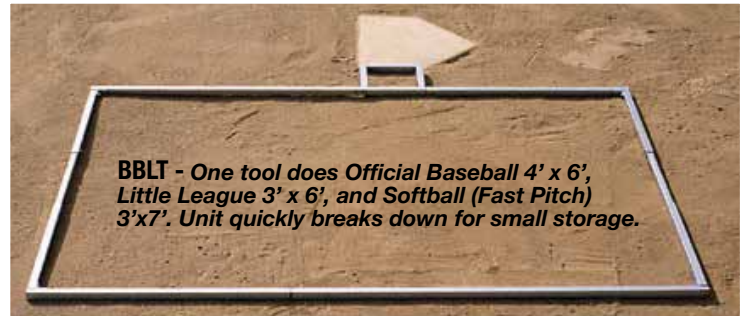

E. Foldable Aluminum Templates



F. Erasers Mat Drags



G. String Winders



A. Steel Drags Field Drags

DR6- 6'W x 6'L galvanized steel mesh
With drag bar and pull rope. 64 lbs
DR3- 3'W x 5'L 6'L galvanized steel mesh
With drag bar and pull rope. 28 lbs
DR33-3'W x 3'L 6'L galvanized steel mesh
With drag bar and pull rope. 27 lbs

B. Cocoa Mat Drags

Natural cocoa fibers "float" across the surface to give a perfect finish
CC4-4'W x 2'L wight tow rope 27lbs
CC6-6'W x 4'L with tow rope 66lbs

C. Standard Steel Templates

Heavy duty galvanized steel with push button connect.

BBOL-Official League 4' x 6' 23lbs
BBSB-Softball 3' x 7'23lbs
BBLL-Little League 3' x 6' 23lbs

D. 3-Way Adjustable Batter's Box Template

One tool does it all. Push button design will make it easy to adjust from Official League to Softball to Little League. 24lbs

E. Foldable Aluminum Templates

Best template on the market. Lightweight, easy to store and ship. Aluminum frame won't rust.

BBFOL-Official League 4' x 6' 20lbs
BBFSB-Softball 3' x 7' 19lbs
BBFLL-Little League 3' x 6' 18lbs

F. Erasers Mat Drags

Most popular grooming mat on the field
Lightweight and easy to store, will not Harm grass, pitchers mounds or home plate.

ER6-6.5'W x 2'L with tow rope 25lbs
ER5-5'W x 3'L with tow rope 23lbs
ER3-3'W x 5'L with tow rope 22lbs

G. String Winders

- High Impact Plastic
- 400' Heavy Duty Nylon twine
- 2 - 10" steel spikes
LSR - Caddy Style
LSH - Hand Held

**A. Field Lining Set
FMS**



**B. 50 lb. Capacity Liner
FL50**



**C. 50 lb. Capacity Liner
FP50**



**D. 100 lb. Capacity Liner
DL100**



**E. 50 lb. Capacity Liner
DL50**



**F. 50 lb. Capacity Liner
2L50**



**G. 25 lb. Capacity Liner
FL25**

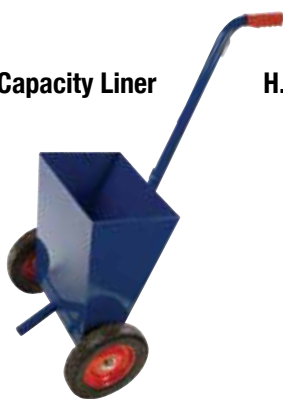

**H. 200 yd. Capacity Liner
FLJ2**



**I. 35 lb. Capacity Liner
DL35**



**J. 25 lb. Capacity Liner
2L25**



Field Lining Set.

A. Football Practice or Band Lining Set.

FMS - Marks complete football field: Set boundary lines, goal lines, every ten yard lines and hash marks. Great for band practice fields as well. Set includes 30 sockets with plugs. Complete installation accessory kit.

B. FL50 - 50 lb. capacity, four 8" wheels. 2" - 4" line width.

C. FP50 - 50 lb. capacity, four 10" pneumatic wheels.

Dry Field Liners. All Liners Are Made With Steel Augers.

D. DL100 - 100 lb. capacity, four **No-Flat soft tires**. All steel unit w/ handle mounted control lever, foam-rubber hand grips and steel axle. 2" - 4" line width.

E. DL50 - 50 lb. capacity, four 8" hard wheels. All steel unit w/ handle mounted control lever, foam-rubber hand grips and steel axle. 2" - 4" line width.

F. 2L50 - 50 lb. capacity, two 8" wheels. All steel unit with on/off lever on handle. Made in the USA.

G. FL25 - 25 lb. capacity, lever shut-off 2" line width, two 8" wheels.

H. FLJ2 - 200 yard capacity, no shut-off, 2" line width, two 6" wheels.

I. DL35 - 35 lb. capacity, two 8" hard wheels. All steel unit w/ handle mounted control lever, foam-rubber hand grips and steel axle. 2" - 4" line width.

J. 2L25 - 25 lb. capacity with two 8" wheels. All steel unit with on/off lever on handle. Made in the USA .

A. GRACO S100



B. WLH/510



C. WLL6/500



D. WLL6/515



E. 550



F. 501



A. GRACO S100

- ▶ Graco high-pressure airless paint spray technology coats both sides of the grass blade in a single pass.
- ▶ Durable light-weight design at 80 lbs it's easy to load and unload.
- ▶ Exclusive tall-wheel cart rolls easily over ruts and cleat marks, resulting in less operator fatigue & straighter lines.

B. WLH/510

- ▶ Designed for use with Ameri-Stripe aerosol paint.
- ▶ Easy to use for stenciling or line touchups
- ▶ Made of durable plastic construction.
- ▶ 34 inches long with wheel for operating ease.

C. WLL6/500

- ▶ Works with 20 oz. can aerosol cans.
- ▶ Large 10 inch turf wheels.
- ▶ Folding handle and all metal frame.
- ▶ Easy line width adjustment

D. WLL6/515

- ▶ Works with 20 oz aerosol paint cans.
- ▶ 7 inch turf wheels
- ▶ Folding handle & all metal frame.
- ▶ Easy line width adjustment
- ▶ Holds six cans

E. 550

- ▶ 4 large, 10" solid rubber wheels. NO flats
- ▶ Wider axel & all metal frame
- ▶ Works with 20 oz aerosol paint cans.
- ▶ Easy line width adjustment

F. 501

- ▶ Works with 24 oz Monster cans Only
- ▶ Large 10 in turf wheels
- ▶ Folding handle and all metal frame
- ▶ Easy line width adjustment.
- ▶ Wider Axle for more stability.

A. Quarterback Arm Play Holders

APH adult

Single Holder
2 Colors



APH3 adult

Triple Play Holder
7 Colors



C. Protective Eyeshield PES

Eyeshield

F. Leader Next Vision™ Eyeshield PNS



A. Arm Play Holders.

APH - Adult size Single Play Card Holder. 6 1/4" length soft wrist band of stretch terry cloth with clear envelope to hold included playcard. **Black or White.**

APH3 - Adult size Triple Play Card Holder with velcro close front. Holds 3 times the information. 7 Colors: **Black, White, Scarlet, Gold, Royal, Navy & Pink.**

APHY - Youth size Single Play Card Holder. 5" length. **Black & Pink.**

APHY3 - Youth size Triple Play Card Holder. 5" length. 7 Colors: **Black, White, Scarlet, Gold, Royal, Navy & Dk. Green.**

B. Quarterback Field Towels with Velcro.

QFT- **White** cotton. 4-1/2" W x 12" L.

Velcro around belt. Poly bagged.

QFT-PK - **Pink** cotton. 4-1/2" W x 12" L.

Velcro around belt. Poly bagged.

B. Quarterback Field Towels

APHY youth

Single Play Holder
2 Colors

APHY3 youth

Triple Play Holder
7 Colors



D. Cleat Wrenches



SCW

FCW

E. ASI Universal Replacement Cleats



Synthetic/Pro Turf Cleats

"Cleats with Teeth"

G. Mouth Guards with Lip Protector

MG9 (adult)

MG5 (youth)



Air Holes

New Color: Lime Green

H. Athletic Specialties Mouth Guards

MG2 (adult w/strap)

MG4 (youth w/strap)

MG7 (adult strapless)

MG3 (youth strapless)



G. Mouth Guard w/ Lip Protection.

MG9 - Adult size. Protects lips, mouth and teeth. Exclusive patented breathing holes. Pliable thermo rubber for cushioning comfort. Custom fit one-piece strap. Retail Packed. \$3,000 Dental Warranty.

16 Colors: **Black, White, Scarlet, Royal, Yellow, Navy, Dk. Green, Orange, Pink, Purple, Maroon, Columbia Blue, Silver, Vegas Gold, Tan & Lime Green.**

MG5 - Youth size. 7 Colors: **Black, White, Pink, Scarlet, Yellow, Navy & Royal.** Retail Packed.

H. ASI Mouth Guards.

MG2 - Adult size w/strap in comfortable dental vinyl with hint of mint. Easily cut to fit youth size mouth. Hot water custom fitted in seconds. Poly bagged. \$3,200 dental warranty.

10 Colors: **Black, Scarlet, Royal, Gold, Kelly, Navy, Maroon, Purple, Orange & Pink.**

MG7 - Adult size without strap. Form-fit type. Poly bagged. \$3,200 dental warranty.

5 Colors: **Clear, Gold, Scarlet, Royal & Black.**

MG4 - Youth size with strap. Poly bagged. \$3,200 dental warranty.

WARNING: These pieces of protective equipment are designed to reduce the possibility of head concussion or injury to the specific body part which they cover. Use of any equipment does not guarantee that the user will be protected from serious, disabling or permanent injury while playing football.

A. Lightweight Foam Pads

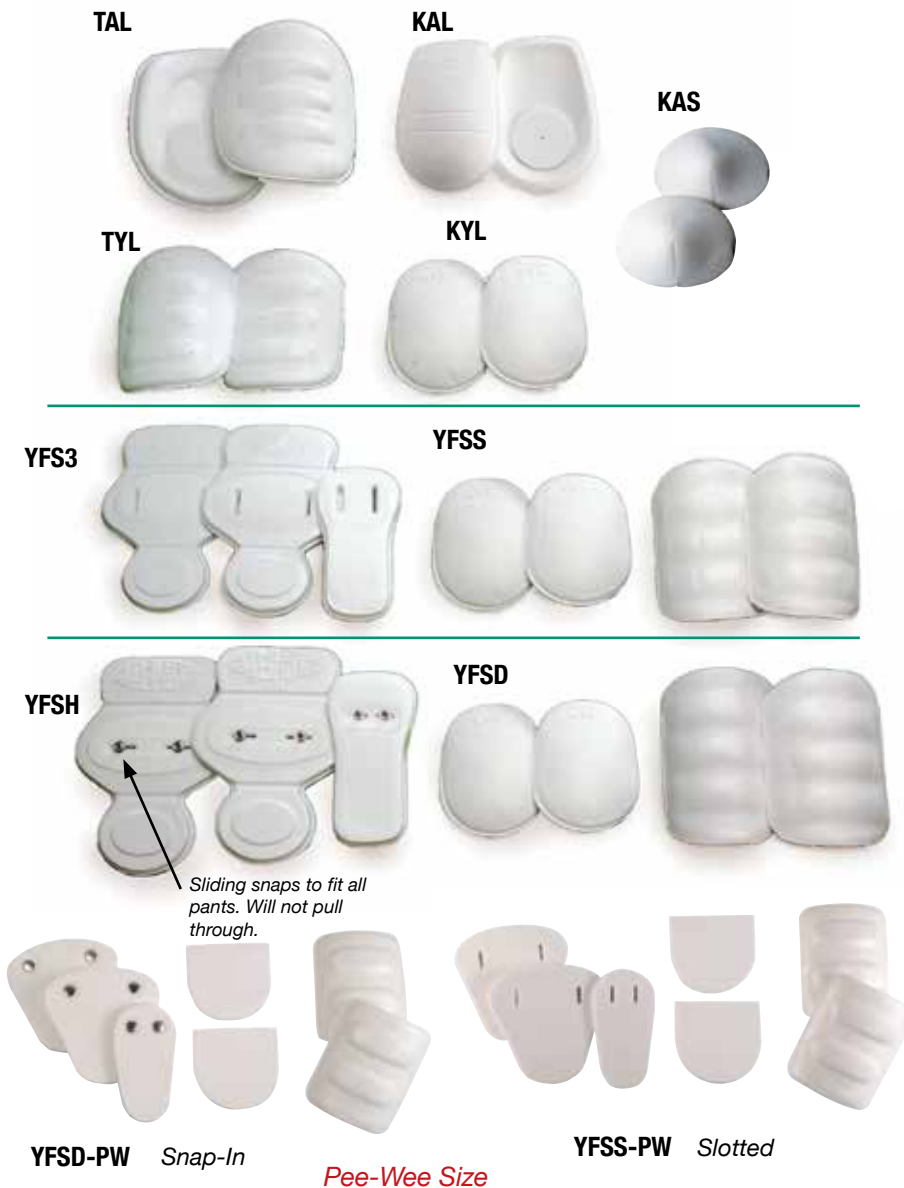

C. Draw Cord DRC



A. Lightweight Protective Pads.

TAL - Adult Thigh Pads with Plastic Insert.

Size: 9" x 6 1/2".

KAL - Adult Knee Pads. Air Cushioned for added protection & comfort. Size: 8" x 6".

KAS - Lightweight vinyl coated foam knee pads. Size: 5" x 4".

HAL - Deluxe Adult 3-Piece Slotted Hip Pad set with heavy duty plastic shell for added protection & durability. Size: 11" x 9 1/2".

TYL - Youth Thigh Pads with Plastic Insert. Size: 7 1/2" x 6".

KYL - Youth Knee Pads. Size: 7" x 5".

HYL - Deluxe Youth 3-Piece Slotted Hip Pad Set with heavy duty plastic shell for added protection & durability. Size: 10 3/4" x 8".

YFSD - Deluxe Youth 7-Piece Sliding Snap-In Pad Set. 2 knee pads, 2 thigh pads with plastic insert, and 3-piece reinforced sliding snap-in hip pads. Adjustable sliding snaps assure an excellent fit on any pant.

YFSS - Deluxe Youth 7-Piece Slotted Pad Set. 2 knee pads, 2 thigh pads with plastic insert, and 3-piece slotted hip pads.

YFS3 - Youth 3-Piece Slotted Hip Pad Set.

YFSH - Youth 3-Piece Sliding Snap-In Hip Pad Set.

YFHO - Youth Sliding Snap-In Tailbone Pad.

HPTO - Youth Slotted Tailbone Pad.

Pee-Wee 7-Piece Pad Sets. Fits pant size: XS - S

YFSD-PW - Snap-In.

YFSS-PW - Slotted.

B. Pant Laces.

FPL - Round Nylon, end-tipped.

36" length, 15 colors. Sold per gross.

15 Colors: White, Black, Scarlet, Royal, Gold, Navy, Orange, Purple, Kelly, Maroon, Silver-Gray, Dark Green, Vegas Gold, Columbia Blue and Tan.

C. Draw Cord.

DRC - White round nylon draw cord on 100 yd. Spool.

WARNING: These pieces of protective equipment are designed to reduce the possibility of head concussion or injury to the specific body part which they cover. Use of any equipment does not guarantee that the user will be protected from serious, disabling or permanent injury while playing football.

A. Vinyl-Dipped Knee Pads



B. Vinyl-Dipped Thigh Pads

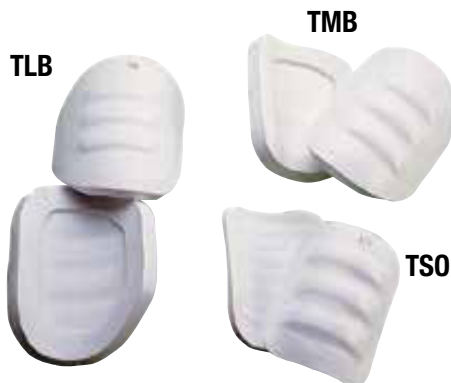

C. Knee/Elbow Pads



D. Shoulder Cushion SCV

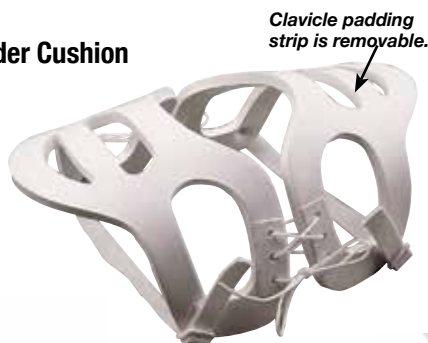

E. Hand Warmers



F. Football Belts



A. Knee Pads. Vinyl Dipped.

KLA - Large adult size. 8" x 6" x 3/8" thick. Air cushioned for added protection & comfort.
KMA - Adult size. 6 3/4" x 5 1/2" x 3/8" thick. Air cushioned for added protection & comfort.
KSO - Youth size. 6" x 4 1/2" x 3/8" thick. Formed to fit knee.

B. Universal Thigh Pads. Vinyl Dipped.

TLB - Large Adult Size. 9" x 6 1/2" x 3/8" thick. Reinforced with bumper edge.
TMB - Adult size. 8 1/2" x 6" x 3/8" thick. Reinforced with bumper edge.
TSO - Youth size. 7 1/4" x 5 1/2" x 3/8" thick.

C. Knee/Elbow Pads.

KPEA-BK - Adult Size. Easy-slide knit with contoured 5/8" padding. Comfort knit elastic with no-bind cutout at back.
KPEY-BK - Youth Size.

17 Colors: White, Black, Scarlet, Royal, Navy, Orange, Gold, Purple, Kelly, Maroon, Silver-Gray, Cardinal, Dark Green, Vegas Gold, Columbia Blue, Brown and Pink. (Brown, Columbia Blue, Vegas Gold and Pink not in PWL).

D. Shoulder Cushion. Vinyl-Dipped.

Shoulder Cushions are designed to fit under the shoulder pads. May be cut to remove padding over the clavicle area.
Black and White.
SCV - Adult size Universal model of 1/2" coated vinyl with underarm straps. Sized front and rear for superior fit and protection.

E. Hand Warmers.

Soft fleece keeps hands warm & dry from inclement weather. Adjustable waist strap fits all. **White or Black.**
HWMB - Black.
HMMW - White.

F. Football Belts. Standard Length is 60".
PWB - 1" polypropylene web belt with heavy duty "D" rings & no-fray ends. Cut & sear to shorten.
PWB2 - Same as above, but length is 72".
PWL - Heavyweight 1-1/4" polypropylene web belt. As above in wider width for greater support.
PWL2 - Same as above, but length is 72".

WARNING: These pieces of protective equipment are designed to reduce the possibility of head concussion or injury to the specific body part which they cover. Use of any equipment does not guarantee that the user will be protected from serious, disabling or permanent injury while playing football.

A. Soft Cup Chin Straps

2-Point



YCS2/RCS2

Youth chin straps include USB buckles.

Adult chin straps include SSBX stainless steel buckles.

4-Point Low



YCS4/RCS4



BCS3
BYS3



BCS3B
BYS3B

4-Point High



RCSB



BCS9 / BCS9S
BYS9



BCS9B
BYS9B



RCS9



BCS9B-S



BCS9
scarlet
royal
navy

B. Chin Strap Buckles

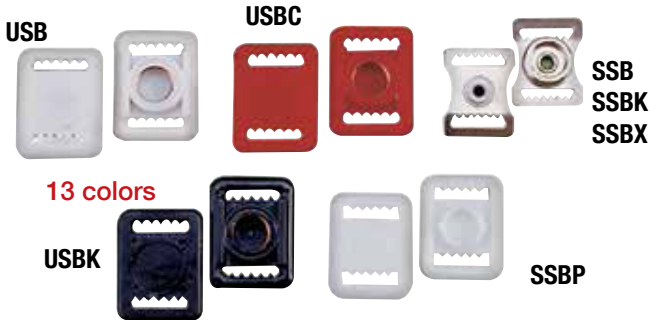

13 colors

USBK

SSBP

C. Plastic/Stainless Steel Buckles



PBSS

Pat. No. 5,259,096

A. Chin Straps.

2-Point Chin Straps.

YCS2 - Youth - Vinyl Ribbed Flannel Cup.

RCS2 - Adult - Vinyl Ribbed Flannel Cup.

4-Point Low-Hook-Up Chin Straps.

YCS4 - Youth - Vinyl Ribbed Flannel Cup.

RCS4 - Adult - Vinyl Ribbed Flannel Cup.

BCS3 - Adult - Sewn Vinyl Straps & Cup. **White.**

BYS3 - Youth - Sewn Vinyl Straps & Cup. **White.**

BCS3B - Adult - Sewn Vinyl Straps & Cup. **Black.**

BYS3B - Youth - Sewn Vinyl Straps & Cup. **Black.**

4-Point High Hook-Up Chin Straps.

RCSB - Adult - Vinyl Ribbed Flannel Cup w/"D" Rings.

BCS9 - Adult - Sewn Vinyl Straps & Cup.

White, Black, Scarlet, Royal & Navy.

BCS9-S - Adult - Longer Straps to fit Schutt® & Riddell® Helmets. **White.**

BCS9B-S - Adult - Longer Straps to fit Schutt® & Riddell® Helmets. **Black.**

BYS9 - Youth - Sewn Vinyl Straps & Cup. **White.**

BCS9B - Adult in **Black.**

BYS9B - Youth in **Black.**

RCS9 - Youth - Flannel Cup. Longer, lower straps. Fits slots in Schutt® Youth Helmets.

B. Chin Strap Buckles.

USB - Unbreakable Safety Chin Strap Buckles - no sharp edges or metal to injure players. Pat. No. 5,259,096.

USBK - As above in **Black.**

USBC - Same USB Buckle in 11 colors.

Scarlet, Cardinal, Royal, Dark Green, Maroon, Navy, Orange, Gold, Kelly,

Purple and Pink . Chin Strap Buckles.

SSB - Metal Buckles.

SSBK - Metal Buckles, **Black** Finish.

SSBX - Stainless Steel Buckles.

SSBP - Plastic Buckles.

C. Plastic/Stainless Steel Buckles.

PBSS - Polycarbonate Plastic Buckle with 100% stainless steel socket & solid rivet. Longer in length for those big fingers. Sharp teeth to dig into straps. Cuts down on wear & tear on apparel and will not cut players face. **White**

PBSSK - As above in **Black.**

PBSSC - As above in **9 Colors.** See price list.

WARNING: These pieces of protective equipment are designed to reduce the possibility of head concussion or injury to the specific body part which they cover. Use of any equipment does not guarantee that the user will be protected from serious, disabling or permanent injury while playing football.

Athletic Specialties Chin Straps
Pro 4-Point High Hook-Up w/ D Rings

Matching color #USB Buckles



11 Colors:
 White, Black, Royal, Scarlet, Navy,
 Pink, Gold, Dark Green, Orange,
 Purple and Maroon.

PRO50 - adult vinyl cup
 PRO25 - youth vinyl cup

Pro 4-Point Chin Straps
with Sewn Straps

Matching color #USB Buckles



11 Colors:
 White, Black, Royal, Scarlet, Navy,
 Pink, Gold, Dark Green, Orange,
 Purple and Maroon.

High Hook-Up / Sewn Straps
 PRO60S - adult vinyl cup
 PRO30S - youth vinyl cup

Jaw Pads for Schutt® Helmets



Item JPSCH

Item JPSVH

Item JPSVP

Jaw Pads for Schutt® Helmets.

Jaw Pads are sold per dozen pair (12-Right, 12-Left) per size (thickness). White.

- JPSCH - Fits Schutt® Vengeance Pro LTD II
- JPSVH - Covers only - Vengeance Pro LTD II
- JPSVP - Fits Schutt® F7 and Vengeance Pro LTD II



Low Hook-Up / Sewn Straps
 PRO40S - youth vinyl cup

	XS	S	M	L	XL	2X	3X
	1/2"	5/8"	3/4"	7/8"	1"	1 1/8"	1 1/4"
JPSVH	X	X	X	X	X	X	X
JPSVP		X	X	X	X	X	X
JPSCH				X	X	X	X

WARNING: These pieces of protective equipment are designed to reduce the possibility of head concussion or injury to the specific body part which they cover. Use of any equipment does not guarantee that the user will be protected from serious, disabling or permanent injury while playing football.

Helmet Hardware & Pumps

A. Helmet Hardware

sold in bags of 50

For chin-strap buckle to snap onto.



CRS
Youth
Mask

CAG
Adult
Mask



TNS
CSS
CSSX



CSL



CHB
CHS
CHX
CHXB
PHS
PHSX



SSW



DR1

B. T-Nut Wrench



TNW2

C. Stainless Steel T-Nuts



TNSX



TNMX



TNLX

D. Helmet Inflation Kit

poly bagged
HIK



E. Helmet Inflator Pump

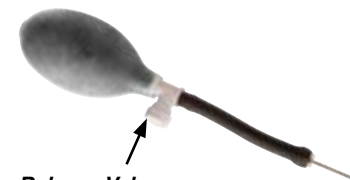

Release Valve

F. Lubricant

GLY



G. Helmet Screws for Schutt® and Xenith®



SLAS



XBAS

J. Hardware Display Card

DB3 FREE



H. Packaged Hardware



I. Helmet Hardware Kit

HKX



A. Helmet and Face Guard Hardware. Bags of 50.

CRS - Face Guard Strap. "Reverse type" for smaller diameter coated wire face guards.

CAG - Face Guard Strap. For larger diameter coated wire face guards.

TNS - Short T-Nut (1/8"). (Screws into **CSS/CSSX**).

TNM - Medium T-Nut (3/8").

TNL - Long T-Nut (1/2").

CSS - Short Stud Screw (3/16") (Screws into **TNS**).

CSSX - Short Stud Screw - 100% Stainless Steel Screw & Cap.

CSL - Long Stud Screw (3/8").

CHB - Combo Head Screw (1/2"), **Black**.

CHS - Combo Head Screw (1/2"), **Gold**.

CHX - Stainless Steel Combo Head Screw (1/2").

CHXB - Stainless Steel Combo Head Screw (1/2"), **Black**.

PHS - Phillips Head Screw (1/4").

PHSX - Phillips Head Stainless Steel Screw (1/4").

SSW - Stainless Steel Washer.

DR1 - D-Ring (1").

B. T-Nut Wrench.

TNW2 - Flat for easy access. Fits all T-Nuts.

C. Stainless Steel T-Nuts. Bags of 50.

TNSX - S.S. Short T-Nut.

TNMX - S.S. Medium T-Nut.

TNLX - S.S. Long T-Nut.

D. HIK - Helmet Inflation Kit contains 1 #IPR helmet pump, 2 short needles & 1 #GLY glycerine lubricant in retail poly bag.

E. IPR - Helmet Pump with push button quick release air valve with 9/16 needle.

F. GLY - Glycerine Lubricant for needles. 1 oz.

G. Helmet Screws. Bags of 50.

SLAS - Phillips Head Screw, 1/4" Black.

Use for Schutt® Helmet Liner Attachment.

XBAS - Stainless Steel Combo Head Screw, 7/32".

Use for Xenith® Helmet Bonnet Attachment

H. Packaged Hardware.

FGDS - Set of hardware and 6 special face guard straps (for Riddell type plastic face guards).

FGAG - Set of hardware & 4 cage straps (for larger diameter wire) to mount face guards.

FGRS - Set of hardware & 4 cage straps (for smaller diameter wire) to mount face guards. "Reverse Type".

FGH - Set of hardware only - no face guard straps.

RHK - Riddell Revolution® Helmet Face Guard Kit. 16-piece packaged set. See price list for details.

I. HKX - Helmet Hardware Repair Kit. 4 each TNS T-nuts, 4-CSS stud screws & 4 SSB chin strap buckles.

J. DB3 - **FREE** display card of all helmet & shoulder pad hardware, cleats & track spikes. Great item for equipment managers.

WARNING: These pieces of protective equipment are designed to reduce the possibility of head concussion or injury to the specific body part which they cover. Use of any equipment does not guarantee that the user will be protected from serious, disabling or permanent injury while playing football.

A. Shoulder Pad Hardware



B. Lace Locks



C. Shoulder Pad Elastic

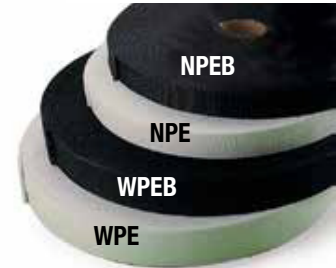

D. Deluxe Field Repair Hardware Kits

DRK - adult
YDRK - youth



E. Field Repair Hardware Kits

FRK - adult
YRK - youth



F. Shoulder Pad Elastic w/T-Hooks



G. Equipment Manager's Field Pack w/Hardware

EFP



H. 40" Shoulder Pad Laces

SPB (black)
SPL (white)



I. Shoulder Pad Hanger

SPH

A. Steel Shoulder Pad Hardware.

Sold in bags of 50.

- STH2 - 1-1/2" Swivel T-Hook.
- STH1 - 1" Swivel T-Hook.
- TH2 - 1-1/2" T-Hook.
- TH1 - 1" T-Hook.
- KS2 - 1-1/2" Key-Hole Fastener.
- KS1 - 1" Key-Hole Fastener.
- SS2 - 1-1/2" Slide.
- SS1 - 1" Slide.
- JH1 - 1" J-Hook Fastener.

Black Plated Hardware. Sold in bags of 50. T-hooks & key slot fasteners with durable black plating.

- TH2B - 1-1/2" T-Hook, **Black.**
- TH1B - 1" T-Hook, **Black.**
- STH2B - 1-1/2" Swivel T-Hook, **Black.**
- KS2B - 1-1/2" Key-Hole Fastener, **Black.**
- KS1B - 1" Key-Hole Fastener, **Black.**

B. Lace Locks. Sold in bags of 50.

- BBL - For ease in opening or closing all items requiring a draw cord. Great for bags, clothing, camping gear. **Black.**
- PLS - Plastic Lock for shoulder pad laces.

C. Shoulder Pad Elastic.

- Highest quality heavy duty elastic. Sold in 25 yard rolls.
- NPE - 1" **White** elastic.
- NPEB - 1" **Black** elastic.
- WPE - 1-1/2" **White** elastic.
- WPEB - 1-1/2" **Black** elastic.

D. Deluxe Field Repair Hardware Kits.

- DRK - Similar to FRK kit with 60% more hardware & elastics. Additional tools include 2 way pump, whistle/lanyard, ball sealant, inflation gauge & needles. Extra room for customer to add items.
- YDRK - Youth Level Deluxe Equipment & Tool Box. As above-gearred to smaller equipment and players.

E. Field Repair Hardware Kits w/Plastic Carry Case.

- FRK - Varsity Level Repair Kit. Assortment of helmet & sh. pad hardware. Also included are laces, football cleats and wrench, 2 screw drivers, pliers & helmet pump for quick repairs.
- YRK - Youth Level Repair Kit. As above-gearred to smaller equipment and players.

F. Shoulder Pad Elastic With T-Hooks.

- Sold per pair. Poly bagged.
- SPE2 - 1-1/2" **Black** elastic (WPEB) with **Black** T-hook (TH2B).
- SPE1 - 1" **Black** elastic (NPEB) with **Black** T-hook (TH1B).

G. Equipment Manager's Field Pack.

- EFP - Portable fanny pack includes: 25-TNSX (S.S. T-Nuts), 25-CHS (Screws), 15-CAG (Face Guard Straps), 1-SCW (Cleat Wrench) and 1-TNW2 (T-Nut Wrench). Multiple pockets to carry hardware items. **Black** only.

H. 40" Shoulder Pad Laces

- Tough, round nylon end-tipped. Sold by the gross.
- SPB - **Black.**
- SPL - **White.**

I. Shoulder Pad Hanger.

- SPH - Powder coated black steel. Holds 14 pads. Sold per each.

WARNING: These pieces of protective equipment are designed to reduce the possibility of head concussion or injury to the specific body part which they cover. Use of any equipment does not guarantee that the user will be protected from serious, disabling or permanent injury while playing football.

Football - Web Belts & Flag Belt Sets

A. Football Belts



1" **PWB**
PWB2
17 Colors

1 1/4" **PWL**
PWL2
13 Colors

B. Belt Stringer Tool BST



C. One Piece Flag Football Belts 6 colors

Belt comes off with flag!

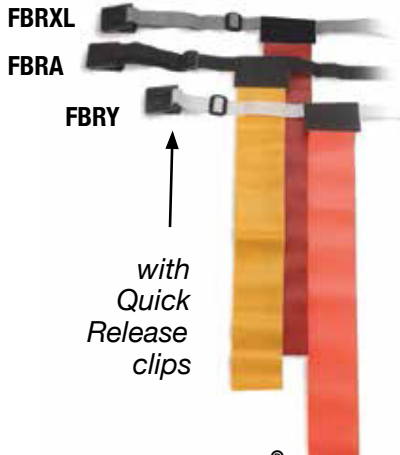

FBRXL
FBRA
FBRY

with
Quick
Release
clips

D. Adjustable Flag Football Belts 7 colors; *New: Pink*



FBS2

FBFO

FBS3

Flags come off belt

All flag belts sold per each set.

E. Retail Flag Belts FBS2R



F. Sonic Flag-A-Tag® Flag Football Belts

2 colors
FATG
FATS

All flag belts
sold per each.



"Pop" is heard
when flag is
pulled.

G. Sideline Official's Pinnies

LMS
LMS-O



H. Official's Pinnie PNO



A. Football Belts. 60" length.

PWB - Heavyweight 1" polypropylene web belt with nickel-plated "D" rings & heat-sealed ends. Cut & sear to shorten. 17 colors.

PWB2 - Same as above but length is 72".

PWL - Heavyweight 1-1/4" polypropylene web belt. As above in wider width for greater support. 13 colors.

PWL2 - Same as above but length is 72".

17 Colors: White, Black, Scarlet, Gold, Royal, Navy, Orange, Purple, Kelly, Maroon, Silver-Gray, Cardinal, Dark Green, Vegas Gold, Columbia Blue, Brown and Pink. (*Brown, Columbia Blue, Vegas Gold and Pink not in #PWL*).

B. Belt Stringer Tool.

BST - Quickly threads belts and draw cords through pant tunnels.

C. One Piece Flag Football Belts.

3 sizes. 6 Colors.

FBRY - Youth sized belt comes off with the flags when grabbed. 3 flags per belt sewn directly to

White web adjustable belt. Adjusts from 25" to 30".

FBRA - Adult sized with **Black** web belt, adjusts from 31" to 38". As above.

FBRXL - Extra large size with **Gray** web belt, adjusts from 39" to 46". As above.

D. Adjustable Flag Football Belts.

FBS2 - 2 flag football belt sets. Flags come off belt when grabbed. Sliding tabs with Velcro adjust to any position on large size 1" web belts with "D" rings. Sold per each belt set.

FBS3 - 3 flag football belt sets. Same as FBS2 with 3 flags per belt. Sold per each belt.

FBFO - Flags and belt tabs only. Per pair.

7 Colors: Gold, Scarlet, Royal, Orange, Kelly, Black and **Pink**.

E. Retail Packaged Flag Belts.

FBS2R - One each FBS2 flag belt in poly bag with header. **6 Flag Colors:** Scarlet, Royal, Gold, Green, Orange, & Black.

F. Sonic Flag-A-Tag® Flag Football Belts.

2 Colors: Gold and Scarlet.

The "sonic" release brings a new dimension to the game. Socket releases flag when pulled, and a loud "POP" is heard. 52" Belt length. Plastic belts and nylon flags are the same color. 2 flags per belt set. Pat. No. 6,241,631.

Sold per each belt set.

FATG - Gold.

FATS - Scarlet.

G. Sideline Official Pinnies.

LMS - Set of 3 nylon pinnies with adjustable velcro closure. Bright **Gold** with **Black** markings. Two for chain set with **Black** diamonds, one for down box with **Black** stripes.

LMS-O - As above, but Orange/Black.

H. Official's Striped Pinnie.

PNO - **Black and White** striped nylon with front velcro closure. One size fits all.

A. Scrimmage Vests



SV4 adult
SV3 youth

Elastic bottom



Retail Packaged
Scrimmage Vests

B. Heavy Duty Scrimmage Vests



SV5

The choice of the Pros
Extra strong
pull-over style

Large generous cut
No elastic bottom

C. Adjustable Scrimmage Vests



SV7

Extra
Tough
Nylon

D. Front Velcro® Closure Scrimmage Vest



SV9



E. Skull Caps

SC-Black
SC-White



F. Nylon Pinnie

PN2R



G. Deluxe Practice Jersey

FJ11 / FJ21

Screen Printing Available



8 colors: Black, Navy, Royal, Scarlet, Dk. Green, Purple, Lt. Gold & White.

H. Scrimmage Helmet Covers

SCP
SCP2



A. Scrimmage Vests.

100% polyester mesh is generously cut to fit over shoulder pads. Reinforced stitching on armholes & neck. Has label size tag. Each poly bagged. **14 Colors: Gold, Scarlet, Royal, Navy, Kelly, Black, Purple, Orange, White, Cardinal, Maroon, Burnt (Dark) Orange, Dark Green & Pink.**

SV3 - Youth.

SV4 - Adult.

SV4R - Adult in retail package.

SV3R - Youth in retail package.

B. Heavy Duty Pull-over Nylon Scrimmage Vests.

SV5 - Extra tough material with no elastic bottom in adult size.

5 Colors: Royal, Scarlet, Gold, Black and White.

C. Adjustable Scrimmage Vests.

SV7 - Extra tough nylon mesh has large head opening for easy on/off over the helmet. Open sided vest for no restriction of movement. Heavy duty 1 1/2" elastic/velcro strap closure is completely adjustable for Medium through XXXL sizes. **5 Colors: Black, Scarlet, Royal, Gold & Dark Green.**

D. Velcro Front-Opening Scrimmage Vests.

SV9 - Allows quick on/off without removing vest over the helmet. Extra strong mesh polyester is waist-length without elastic. Adult size.

4 Colors: Scarlet, Gold, Royal & Black.

E. Skull Caps.

Nylon/Spandex fabric will fit any head and can be worn on hot or cold days. Elastic/Silicone beaded brow band insuring reliable, comfortable fit. Machine washable.

SC - Black.

SC - White.

F. Nylon Pinnie.

PN2R - Super lightweight nylon pinnies in one size, fits youth and adult. Adjustable front Velcro closure eliminates hard-to-tie side laces which end up in knots. **6 Colors: Scarlet, Royal, Gold, Kelly, Purple, & Orange.**

G. Deluxe Practice Jerseys.

Heavy weight porthole mesh body. 2 Ply tricot mesh yoke. Belt length. Full athletic cut. Screen printing available.

FJ11 - Adult Sizes: S/M, L/XL, 2X/3X

FJ21 - Youth Sizes: S/M, L/XL

H. Scrimmage Helmet Covers.

SCP - Stretch fabric cap with elastic bottom for best fit. **6 Colors: Orange, Black, Scarlet, Royal, Gold & Dark Green.**

SCP2 - **25% bigger than our SCP.** Fits Riddell®, Schutt® DNA™, Xenith® and Rawlings® Helmets.

2 Colors: Gold & Scarlet

A. Helmet Rack HRAK



B. Shoulder Pad Racks

4 Stack SRAK



2 Stack SRAK-2

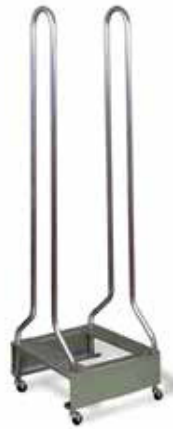

Pro Shoulder Pad Rack SRAK-PRO



C. Kicking Cage & Net FKN FKN-NET



D. Shoulder Pad "Size-A-Pad" SAP



E. Pro Style Kicking Cage w/Net FKPRO



F. "Sports-Dry" Ball Compound DRY



A. Helmet Rack.

HRAK - Heavy gauge steel constructed rack is 64"H x 61"L x 24"W and holds up to 60 football helmets. Can be used for all other sport helmets. Fits through standard doorway. 4" heavy duty swivel wheels that lock into place. 62 lbs. in one carton.

B. Shoulder Pad Racks.

SRAK - Heavy duty galvanized steel construction with 4 easy rolling casters. 66"H x 60"L x 24"W. Holds up to 50 XL pads and 75 youth pads. This very sturdy rack weighs 58 lbs. in one carton.

SRAK-2 - Made for schools on a budget. 66"H x 30"L x 24"W. Holds up to 40 youth pads. 42 lbs. in one carton.

SRAK-PRO - Holds 60 XXL Pads!! Heavy duty steel bottom frame with retractable pull handle and large locking wheels allows for transport on and off the field. Steel uprights with bottom position bar allows for neat and orderly stacking.

C. Punting & Kicking Cage & Net.

FKN - Heavy duty 1 1/2" galvanized steel frame. Breaks down for easy travel & storage. 82" H x 41" W. 34 lbs. Ships UPS.

FKN-NET - Replacement net for #FKN.

FKN-BAG - Carrying Bag for #FKN. Vinyl, zipper closure, shoulder strap and carry handle. Black only. 13" x 7".

D. Shoulder Pad Size-A-Pad.

SAP - Sliding scale gives accurate shoulder width for proper shoulder pad size and fit. Includes carrying bag.

E. Pro Style Kicking Cage with Net.

FKPRO - 2" powder-coated square steel base with weighted bottom for maximum stability. Uprights are 1-5/8" galvanized steel with adjustable top to various angles. Net is HD nylon. Comes with carry bag.

F. "Sports-Dry" Ball Compound.

DRY - Sold in sets of 2 bags compound per box. Put into bag, pail or sealed container & baseballs, footballs, tennis balls, etc. are dry in 15 sec. Once opened, must keep in airtight container.

A. Kicking Tees

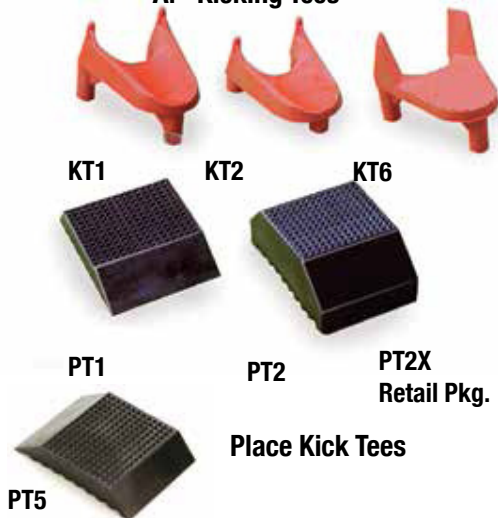

Wizard Half-Inch Tee

D. Ground Zero® Kicking Tees



Triplex® Stealth 3-Way Kicking Tee GT7

A. Kicking Tees.

KT1 - 1" Kickoff Tee. *Orange* molded rubber.
KT2 - 2" Kickoff Tee. *Orange* molded rubber.
KT6 - 2" Soccer Style Kickoff Tee.
Orange molded rubber. For right or left kickers.
PT1 - 1" Extra Point Tee. *Black* molded rubber.
PT2 - 2" Extra Point Tee. *Black* molded rubber.
PT5 - 1/2" Extra Point Tee. *Black* molded rubber.

B. KT5R - 2" Kickoff Tee.

Soccer style, for right-footed kickers.
Orange molded rubber.
KT5L - 2" Kickoff Tee.
 Soccer Style, for left-footed kickers.
Orange molded rubber.

C. KKD - ASI round ring style "tee" can be placed on ground or on extra point block & ball can be tilted to any desired angle. Poly bagged.

KKC2 - ASI ring style tee plus 2" holder to elevate ball position.

E. Hand Down Indicator Counter FCT



H. Heavy Weight Kicking Holder FKH

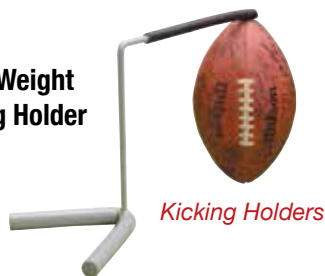

Kicking Holders

D. Ground Zero® Kickoff Tees.

GT2 - 2" Kickoff Tee. *Black* molded rubber.
GT1 - 1" Kickoff Tee *with* "onside kick" feature. *Black* molded rubber.
GT10 - 1" Kickoff Tee *without* "onside kick" feature. *Black* molded rubber.
GT4 - Toe-Tal® Tee. The choice of the pros. 4-in-1 Kicking Tee system. Includes 1" kickoff tee, 1" extra point tee, 2" kickoff tee & 2" extra point tee. *Black* molded rubber.

Triplex™ Stealth™ 3-Way Tee.

GT7 - 2" Kickoff Tee *with* "onside kick" feature. Reshaped middle recess for "Squib Kick". The tip of the ball doesn't touch any tee structure! *Green* molded rubber.

E. FCT - *Black* Elastic Hand Down Indicator/Counter.

F. UWM - *Blue* Throw-Down Referee Bean Bag with weighted flap for folding over waistband.

UWM-W - *White* Throw-Down Referee Bean Bag.

B. Soccer Style Kicking Tees



KT5L

KT5R

C. "Ring Style" Kicking Tees



KKC2

KKD

F. Throw Down Bags UWM



UWM-W

G. Flags



I. Wizard Kicking Stix® Football Holder FKWH



G. Flags.

UMF - Umpire/Referee Flag. 13" square *Yellow* throw flag with weighted center. Rip-stop nylon.

CCF - Coach's Challenge Flag. 13" square *Red* throw flag with weighted center. Coach throws the flag onto the field, telling referees he'd like a play to be reviewed.

Kicking Holders.

H. FKH - Heavy weight enameled steel base with flexible rubber tube to hold tip of ball at desired position.

I. FKWH - Wizard Kicking Stix® Football Holder.

Powder coated steel and aluminum construction. Simply unfold legs and you are ready. Weighted perfectly for windy conditions. Used by the NFL®. Patent No. 5,505,445.

A. Step-Over Training Dummies
SOD8
SOD12



B. Curved Blocking Shields



C. Half Round Dummies



D. Round Stand-Up Dummies

SDR48 SDR42



E. "Man" Shield
MS5



F. Forearm Pads
FAPT

G. Tackle Rings
2 sizes: 36" & 52"
RING36
RING52



A. Step-Over Training Dummies.

"Agile Pad". Increases player agility, stay-in-place trapezoidal design, 18 oz. vinyl coated nylon, double-stitched seams and reinforced handle. Ships UPS.

7 Colors as below.

SOD8 - 8" high x 18" wide x 48" long x 8" top.
SOD12 - 12" high x 18" wide x 48" long x 8" top.

B. Blocking Shield Curved.

BSC3 - 3" thick polyfoam arm dummy 25" x 18".
BSC5 - 5" thick polyfoam arm dummy 25" x 18".
7 Colors as below.

C. Half Round Dummies.

Dual purpose: step-over/blocking.
HRD42 - 42" length x 14" height x 7" thick.
Black and Scarlet. 6 lbs.
HRD6 - 42" length x 16" height x 6" thick.
Black and Scarlet. 6 lbs.

D. Round Stand-Up Dummies.

7 Colors as below.

SDR48 - 48" length x 14" height. 30 lbs.
SDR42 - 42" length x 14" height 25 lbs.

E. "Man" Shield.

MS5 - Man-shaped for more realistic drills. 5" Thick molded poly foam core retains shape and lasts longer. Three handles; 36" tall x 31" wide.
3 Colors: **Black, Scarlet and Royal.**

7 Colors: Black, Scarlet, Royal, Navy, Dark Green, Maroon & Gold.

F. Forearm Pads.

FAPT - 4" thick polyfoam, contoured to forearm with elbow protectors. Sold per Pair.
7 Colors: Scarlet, Black, Royal, Maroon, Gold, Navy, & Dk. Green.

G. Tackle Rings.

RING - Allows players to practice tackling on a moving target without having to collide with another player. Teaches the safer method of "heads-up" tackling. Improves footwork, balance and the placement of head and arms. Can be used with or without pads. Features poly foam, 18 oz. vinyl, double-stitched seams and heavy-duty zipper.
RING52 - 52" high x 12" wide, 20 lbs.
RING36 - 36" high x 12" wide, 16 lbs.
7 Colors: Scarlet, Black, Royal, Maroon, Gold, Navy & Dk. Green.
Ships motor freight.

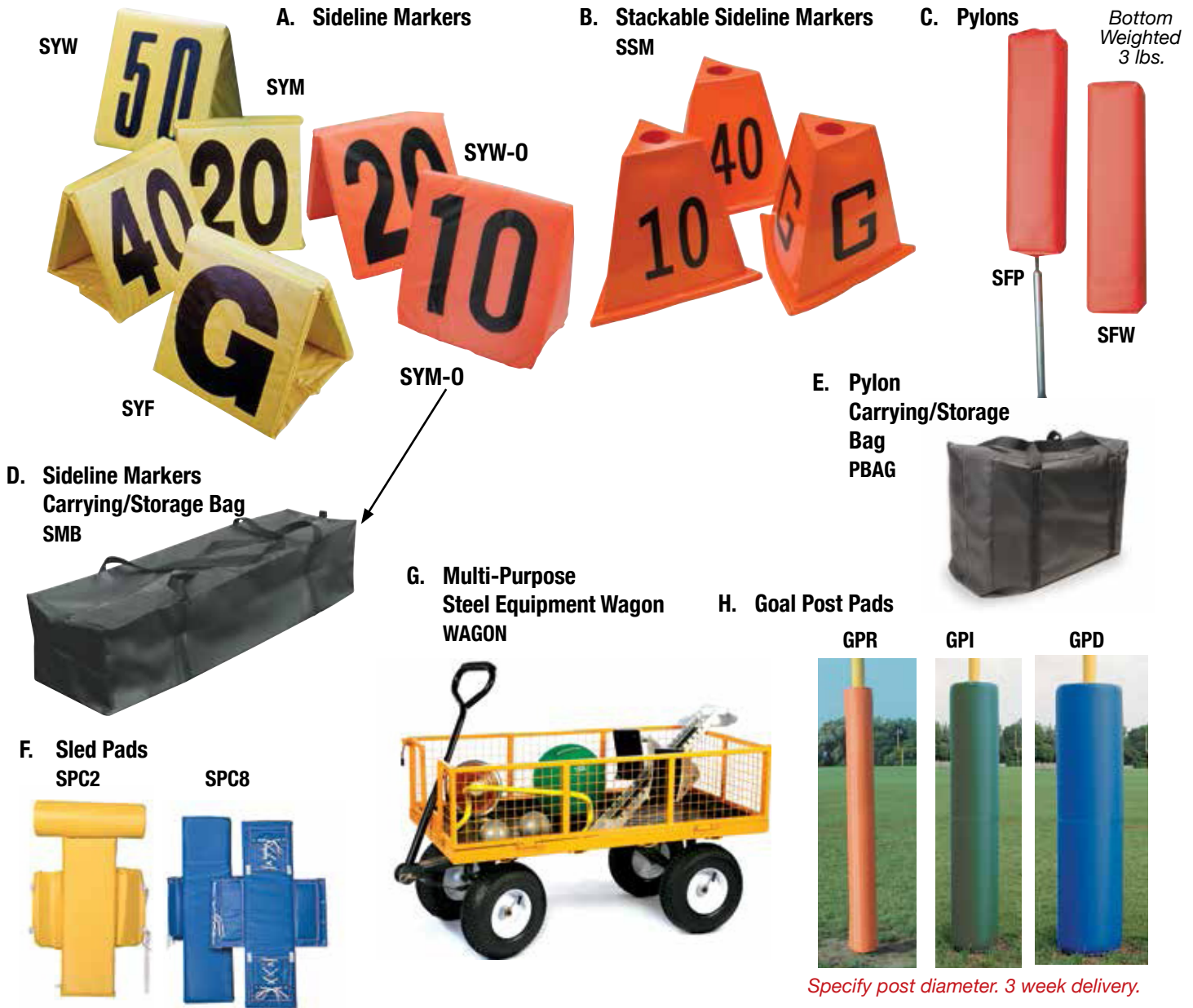

A. Sideline Markers.

11-piece set includes: 2/G, 2/10, 2/20, 2/30, 2/40, 1/50.

SYM - 11 piece set. Two sided, **Black** numbers on **Yellow** covered collapsible foam panels.

SYM-O - Same as above with **Black** numbers on **Orange**.

SYW - Weighted. 11 piece set. Bottom weighted and solid foam filled. Two sided, **Black** numbers on **Yellow**.

SYW-O - Same as above with **Black** numbers on **Orange**.

SYF - 5 piece set for flag football. 2/G, 2/20, 1/40. Two sided, **Black** numbers on **Yellow** collapsible foam panels.

B. Stackable Sideline Markers.

SSM - Stackable Sideline Markers. 13"H, 3 sided pyramid shaped markers. Made of tough, flexible plastic. Stackable for easy storage. 11-piece set includes 2/G, 2/10, 2/20, 2/30, 2/40, 1/50.

C. Pylons.

Line and end zone markers. Set of 4. 18" high x 4" square. Vinyl-nylon with polyfoam core. **Fluorescent Orange**.

SFP - Spring mounted with ground stakes. Returns to upright position when hit.

SFW - Self-standing weighted bottom. 3 lbs. each.

D. Sideline Markers Carrying Bag.

SMB - Holds one complete set (11 pieces) weighted sideline markers. 14" x 14" x 60". 18 oz. vinyl with wrap-around 1-1/2" nylon webbing to form shoulder straps and zippered closure. **Black** only.

E. Pylon Carrying/Storage Bag.

PBAG - Holds 12 weighted pylons. 18 oz. vinyl with wrap-around 1-1/2" webbed handles and zippered closure. **Black** only.

F. Sled Pads.

SPC2 - "T" Blocking shield pad. Includes top "T" Roll & Bottom Pad

SPC8 - Blocking Sled Pad with 8" wide arm attachment. **7 Colors: Scarlet, Black, Royal, Maroon, Gold, Navy, & Dk. Green.**

H. Goal Post Pads

GPR

GPI

GPD

Specify post diameter. 3 week delivery.

G. Steel Equipment Wagon.

WAGON - Heavy-gauge, steel-mesh bed with fold-down sides. Bolts are welded to the bed for quick assembly. Pneumatic 13" wheels. 48" L x 24" W x 12" D. Capacity: 6.0 cu. ft. Weight limit: 1,000 lbs.

H. Goal Post Pads.

Screening available. Made to order. Non-refundable/Non-returnable. **7 Colors: Scarlet, Black, Royal, Maroon, Gold, Navy, & Dk. Green.**

GPR - Goal Post Pad is 6' ht. with 2" shock-absorbing padding. Velcro closure.

GPI - Intermediate Deluxe Goal Post Pad is 6' ht. with 4" formed shock-absorbing padding. Velcro closure.

GPD - Ultra Deluxe Goal Post Pads are 6' ht. with 6" formed shock-absorbing padding. Velcro closure.

A. Down Box & Chain Sets



B. Chain Set Carrying & Storage Bag DBB



C. Wind Direction Banners WDB



D. Football Bag FBAG



E. Chain Yardage Marker YCC



A. Down Box and Chain Sets.

All poles are fully padded and come in a 2 piece section with snap button assembly. All chain sets are galvanized steel with chain swivel assembly. Poles have molded ground stops & crutch tip protectors. Highest quality - lightweight durable construction with fluorescent vinyl covers. Ships UPS.

LS1 - Scholastic Set. Yellow/Black unbreakable Padded Down Box with **Black** foam padding. Chain set is 7' 0" with padded bull's eye with **Black** foam on poles. **Yellow** banners.
DB01 - Padded down box indicator
CS01 - Chain set with padded bull's-eye, padded poles

LS2 - Collegiate Set. Orange/Black unbreakable Padded Down Box with **Black** foam padding. Chain set is 7' 5" with 16" padded bull's eye with **Black** foam on poles. **Orange** banners.
LS2-PINK.
DB02 - Padded Down Box Indicator with padded pole
CS02 - Chain Set with padded bull's-eye and padded poles

LS3- ASI Deluxe Set. Orange/Black unbreakable Padded Down Box is 6' 10" with **Orange** foam padding and 12" Flip-over numbers. Chain set is 7' 6" with 15" padded bull's eye with **Orange** padded banners and poles.

LS3-PINK.
DB03 - Padded down box indicator
CS03 - Chain set with padded bull's-eyes, padded pole
CS03-HO - 2-color horizontal chain sets only. 7' 5" with padded bull's eye with **Black** foam on poles & padded pro banners.

B. Down Box and Chain Set Carrying / Storage Bag.

DBB - Down box and chain set carrying bag. Holds complete set of down box and chain set. 18 oz. vinyl with 1-1/2" webbed handles and double pull zipper. **Black** only.

C. Wind Direction Banners.

WDB - 4" x 42" w/grommets. Attach to top of goal post. High visibility **Fluorescent Orange**. Set of 4.

D. Football Bag.

FBAG - Holds 12 footballs in 32" L x 24" W x 12" H bag. Uniquely constructed of 18 oz. waterproof coated vinyl with interior flap and Velcro closure for quick access to footballs during light rain. Interior dividers separate dry from wet footballs. U-shaped zippered opening with heavy duty 2" webbing wrap-around straps and end carry handles. **Black** only.

E. Clip-on Chain Yardage Marker.

YCC - Marks any five yardage line with numerical dial. Orange.

A. Offense/Defense Line Strip



B. Adjustable Agility Ladder

AAL



AAL27
Economy



Agility Rings

AR11



C. Adjustable Hurdle Set



D. Knee High Training Running Ropes

KHT

KHRR-17
KHRR-20

Rounded safety edges.



E. Football Formation Teacher

FTO
FTD



F. Power Sled Trainer

PST



A. Offensive/Defensive Line Strip.

OLS - Great for teaching your linemen and backs your offensive splits. Running backs can learn the holes by running plays without the offensive line. Made of heavy-duty vinyl, the marker features weights at the ends to keep it flat on the ground. The labeled, removable positions attach to a hook-and-loop fastening strip, allowing you to set up your own custom formations. 39' overall length, 10 1/2" wide black strip with 36" yellow position indicators labeled with 9" letters.

OLS-BAG - Carrying Bag for # OLS. 18 oz. vinyl, zipper closure and carry strap. Black.

B. Adjustable Agility Ladders.

AAL - 30' length ladder with 21 adjustable flat rungs. The user can increase or decrease the distance between 2 rungs for different types of drills. Locking clips at end to join 2 or more ladders. *Includes carrying bag.*

AAL27 - Economy Agility Ladder.

Economy priced for all ages and skill levels. Comes in two sections that measures 27 feet when connected. Rungs are 16" wide and 16" apart. *Includes carrying bag.*

AR11 - Rings Agility Ladder w/Mesh Bag.

11 multi-colored rings made of high impact PVC connected using velcro loops. Connect rings to create different footwork drills. Combine two or more sets to create more complex drills.

C. Adjustable Hurdle Set

AHS - Lightweight PVC hurdles are 23-1/2" wide with 3 height adjustments: 9", 12" and 14". Sold in set of 6.

D. Knee High Training Running Ropes.

KHT - No horizontal bars on ground for athletes to step on and all 4 corners have rounded tubular construction for safety. 1" black powder coated steel frame is 5' wide and 17' long. Running ropes (KHRR-17) adjust in height from 4" to 15" and are included. Unit assembles in 5 minutes and weighs 72 lbs.

KHRR-17 - Replacement Polypropylene Running Rope for **KHT**. 17' length.

KHRR-20 - Replacement Polypropylene Running Rope. 20' length.

E. Football Formation Teacher.

Indoor/outdoor, portable, easy to use teaching tool for all levels. Teach proper alignment for all types formations. Each position measures 12" x 12" and is all-weather rubber construction. Includes ASI Carrying Bag. Use indoors or outdoors.

FTO - Offensive:

1-C, 2-G, 2-T, 2-TE, 2-WR, 3-RB, 1-FB, & 1-QB.

FTD - Defensive:

2-NT, 2-DT, 2-OLB, 2-ILB, 2-MLB, 2-CB & 2-S.

F. Power Sled Trainer.

PST - For power this is the one! Comes with adjustable resistance harness (fits small to XXL). Sled constructed of heavy galvanized steel. Will fit standard or olympic plates - weights not included. UPS. 38 lbs.

A. Flat Proof Ball Sealant FPRO



B. Striping Tape & Clear Vinyl Tape

ST05
ST10
ST20



MT3
MT4

C. Wire Water Bottle Rack WBT (bottle only) WBR (rack only) WBTR (rack & 6 bottles)



D. Locker Room Towels



F. ASI Collapsible Water Bottle Carrier WBC6 (rack & 6 bottles) WBT (bottle only) WBC (rack only)



G. Long Range Megaphone ME3

25 Watt -
1,000 yd. range



H. Portable Air Horn

AHR
Refillable
Air Horn



AHPP
Hand Pump

I. Shoe Laces



HSP
54\"/>

A. Flat Proof Ball Sealant.

Seals/coats inside of ball to close all leaks and punctures in all inflated balls.

FPRO - 1 oz. tube with injection tip.

B. Striping and Floor Tape.

5mm Thickness x 108 ft. Length. High quality plastic tape for marking gym floors, helmet marking & boundary markings on wrestling mats. Widths: 1/2", 1" and 2".

ST05 - 1/2" **ST10** - 1" **ST20** - 2"

7 Colors: White, Black, Scarlet, Yellow, Royal, Orange & Navy.

Transparent Vinyl Mat Tape.

8mm Thickness x 84' Length. Perfectly clear and very strong. Leaves no residue when removed. Each roll is individually wrapped. Widths: 3" and 4".

MT3 - 3" roll, 24 rolls/case.

MT4 - 4" roll, 18 rolls/case.

C. Water/Drinking Bottles.

Wide mouth opaque bottles hold 32 oz.

WBT - One quart size with push/pull tip on cap.

WBR - Sturdy steel wire rack for holding six 32 oz. bottles with removable carrying handle.

WBTR - Retail shrink wrapped rack with 6 water bottles (WBT).

D. Locker Room Towels.

LRT40 - 20" x 40" size. 100% cotton.

Weight: 5 lbs. per dozen. Sold per doz.

LRT44 - 22" x 44" size. 100% cotton.

Weight: 6 lbs. per dozen. Sold per doz.

E. Collapsible Water Bottle Carrier.

WBC - Strong PVC molded carrier. Folds flat for storage. Holds 6-32oz. bottles (WBT).

WBC6 - Retail shrink wrapped carrier with 6 water bottles.

WBT - One quart size with push/pull tip on cap.

F. Long Range Megaphone.

ME3 - 1,000 yard range. 25 watts. Adjustable volume control, powerful siren and shoulder strap. Takes 8 "C" batteries (not included).

G. Portable Air Horn.

AHR - Rechargeable Air Horn fills from any pump or compressor with an air hose chuck.

AHPP - Hand pump for AHR air horn for on the field fill-ups.

H. Bulk Laces - Loose laces per gross (144 each). Bulk pack (no packaging) sold per gross (72 pr.).

Shoe Laces - Polyester.

Flat - available in 7 colors.

LSP - 45"

WSP - 63"

HSP - 54"

XSP - 72"

A. Volleyball Bubble Knee Pads KPV



3 Colors:
Black,
White
& Pink

B. Multi Sport Knee Pads KPEA adult KPEY youth



3
Colors:
Black
White &
Pink

C. 30" Multi-Game Standard VBS (Set) VPOLE (Pole Only) VBASE (Base Only)

H. Mat Strap WMS



VPOLE

D. Volleyball Scorebook SBV



E. Wrestling Scorebook SBW

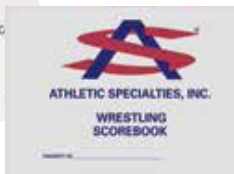

F. Strong Mesh Duffel Bag PDM



28" x 40"

G. Volleyball Drill Cart VBC



I. Flip-A-Scorers

FAS



FAS2

J. Volleyball Lineman Flag Set VOF



VBASE



A. Volleyball Bubble Knee Pads.

KPV - Durable Professional "Bubble Pad". Slides on gym floors. Non-slip 9" length and 100% elastic nylon. **White, Black & Pink.**

B. Volleyball & Multi-Sport Knee/Elbow Pads.

Easy slide knit with contoured 5/8" padding. Comfort knit elastic with no-bind cut-out at back. Retail packaged.

KPEA - Adult size. **White, Black & Pink.**

KPEY - Youth size. **White, Black & Pink.**

C. 30" Multi-Game Standard.

VBS - Includes 2-VBASE and 2-VPOLE.

Sold per pair.

VBASE - 30" dia. base and 250 lbs. for indoor and outdoor use. Non-marring rubber floor protectors and 5" wheels. Blue powder coated. Sold per each.

VPOLE - Made of 2" galvanized steel tubing and adjustable to 10 ft. high. Can also be used for tetherball. Sold per each.

D. Volleyball Scorebook.

SBV - 23 games, space for 18 substitutions. Summary, stats and rally scoring.

E. Wrestling Scorebook.

SBW - Complete scoring information columns. 17 weight classes, dual scoring, 8-man, 16-man and 16-man double elimination tournament brackets, team summaries.

F. Strong Nylon Mesh Duffel Bag with Solid Black Nylon Bottom.

PDM - 28" wide x 40" long. Open mesh allows observation of contents and affords ventilation for drying. Shoulder strap, draw cord and lace lock.

6 Colors: White, Black, Scarlet, Royal, Gold, & Green.

G. Volleyball Drill Cart.

VBC - Measures 48" long, 22" wide, 12" deep, 40" high and holds up to 30 volleyballs. Constructed of heavy-duty black nylon on steel frame with swivel rollers for easy movement. Cart folds for easy storage and transportation. Includes black carrying bag.

H. Wrestling Mat Strap.

WMS - Mat tie straps 16" Length x 2" Wide with non-slip cam buckle. Sold per each.

I. "Flip-A-Scorer" Table Scorer.

FAS - Highly visible 5 1/2" numbers. Scores two teams up to 99.

FAS2 - Deluxe Portable Scorer. A solid long lasting flip scorer with big 9.5" vinyl numbers on a 24" x 12" heavy plastic board. Scores 0-99 with a 5 period indicator. Folds flat for storage and comes with built-in handle strap.

J. Volleyball Lineman Flag Set.

VOF - 2 red nylon flags. 15-1/2" x 11-1/2". Sold as Pair.

Track - Spikes & Accessories

A. Rubber Practice Discus



NEW

**Indoor Brown Discus
GREAT PRICE**

B. Discus

75% rim weight



C. Shot Puts



D. Shot/Discus Carriers



E. Track Spike Kit TSK



F. 12" Aluminum Relay Batons BTN



G. OSLO® All Purpose Stopwatch STPO



I. Track Scorebook SBT



J. Steelex™ Track Spikes TSX



TSX18 1/8" TSX36 3/16" TSX14 1/4"

H. Wrenches



K. Traditional Track Spikes

Heat Treated, Zinc Plated
Bags of 100

Pyramid



TSP18 1/8" TSP36 3/16" TSP14 1/4" TSP38 3/8" TSP12 1/2" TSP58 5/8"

Needle



TSN18 1/8" TSN36 3/16" TSN14 1/4" TSN38 3/8"

Blank



TSB0 1/16" TSPJ 1"

Retail Pkg.



TS__X

Javelin
bag of 20

A. Rubber Discus. Meets H.S. and NCAA specs.

RD10 - 1.0 k. Women's model.

RD16 - 1.6 k. Men's H.S. model.

RD20 - 2.0 k. Collegiate model.

Indoor Rubber Discus. Meets NFHS specs.

Non-marring brown rubber reduces marks on gym floor.

ID10 - 1.0 k. Women's model.

ID16 - 1.6 k. Men's H.S. model.

B. Discus. Steel rimmed high-quality ABS discus. 75% rim weight. Meets High School & NCAA specification.

CD10 - 1.0 k. Women's model.

CD16 - 1.6 k. Men's H.S. model.

CD20 - 2.0 k. Collegiate model.

C. Shot Puts. Individually boxed. Calibrated to meet all specifications.

Outdoor Iron Shots: Cast Iron.

SPR6 - 6 lb. Youth model.

SPR8 - 8 lb. Girls' model.

SPR4 - 4 k. (8.8 lb.) H.S. Girls and Juniors.

SPR12 - 12 lb. Men's H.S. model.

SPR16 - 16 lb. Collegiate model.

Indoor Shots: Cast Iron. hardshell. Filled to exact weights. **Orange** finish.

SPN6 - 6 lb. Youth model.

SPN8 - 8 lb. Girls' model.

SPN4 - 4 k. (8.8 lb.) H.S. Girls and Juniors.

SPN12 - 12 lb. Men's H.S. model.

D. Shot & Discus Carrier.

DSC - Discus Carrier. Tough nylon double pockets with carry handle. Holds any 2 discus or shot puts.

SPC - Shot Put Carrier. Heavy woven poly-mesh with carry handle. Holds any shot put.

E. Track Spike Kit.

TSK - A must for every team. Kit includes:
400 - 1/4" Pyramid 400 - 1/4" Needle
200 - 1/8" Pyramid 200 - 3/16" Needle
100 - 3/8" Pyramid 100 - 3/8" Needle
100 - 1/2" Pyramid 1 - # TSW Wrench
Comes in clear plastic container w/ handle. Plenty of room for other items.

F. 12" Aluminum Relay Batons.

BTN - Lightweight aluminum with rolled-in safety edges. Colors: **Scarlet, Royal, Gold, Silver & Black.**

G. OSLO® Stop Watch with Lanyard.

STPO - Basic stopwatch to 24 hr., 1/100 sec. for 30 min. Cumulative splits. Calendar, time & alarm. Large easy to use buttons. Battery incl.

H. Wrenches.

Quickly loosen or tighten cleats and spikes.

THW - "T" handle track spike wrench.

TSW - Flat steel track spike wrench.

TEW - Small Flat Steel Economy track spike wrench.

I. Track Scorebook.

SBT - 19 meets, 14 events, 3 relays and stats.

J. Steelex™ Spikes with Hex-Base.

Case-hardened steel gives extreme durability for extended life. Hex-base makes it the easiest spike to install & remove ever made. Bagged per 100.

K. Track Spikes.

Zinc plated steel spikes. Bagged per 100.

TS__X - Blister packed per 14. UPC Coded.

A. All Surface Starting Block w/push-down latch SBAS

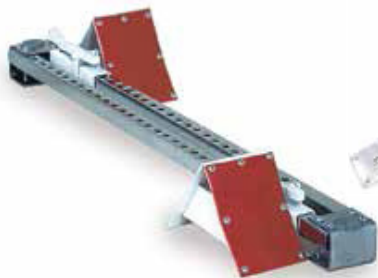

B. Accelerator Starting Block SBC

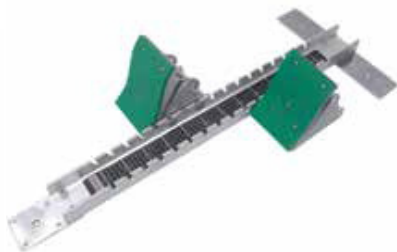

C. 2-Wheel Hurdle Cart HCART



HCART

D. X-Training Hurdle HXT



H. Starting Block Cart TSBC



E. Indoor Starting Blocks SBID

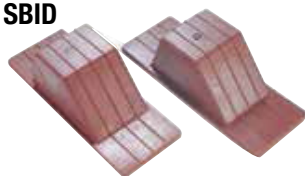

F. Foam Training Hurdle HFT



G. Set of 12 Field Distance Markers MARKER



I. All Aluminum Hurdles

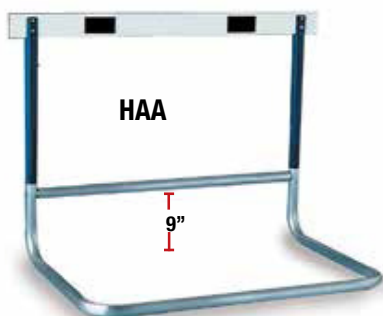

Standard color is natural aluminum.

J. Steel/Aluminum Rocker Hurdle



K. Elite High School Hurdle



HRB Replacement Plastic Gateboard

L. FormFinder Hurdle HTRAIN



Height adjusts from 30" to 39"

Starting Blocks.

A. SBAS - Starting Block - All Surface.

Designed for sure starts on any type of surface. Heavy gauge steel construction with chrome finished runners and powder coated wide pedals. Features a Push-Down Latch for fast pedal adjustment. No loose parts to misplace. 36" Length for easy adaptation to tall or short runners. 13 lbs.

B. SBC - Accelerator Starting Block.

Designed for the high school/collegiate athlete and has unsurpassed value. Solid aluminum pedals attach to stainless steel rail and carrying handle for a precision fit. Pedals adjust to four angles. Includes anchor spikes for synthetic tracks. 14 lbs.

C. HCART - Hurdle Cart - Holds 8-10 hurdles. Steel construction with pneumatic wheels. Just tilt and roll. Ships UPS. 53 lbs.

D. HXT - X-Training Hurdle.

Inexpensive for beginners to use. Adjusts from 16" to 39". Folds flat. 5 lbs.

E. SBID - Indoor Starting Blocks.

Brown rubber blocks. No anchor spikes or pins needed. Foot pressure behind the blocks provides a non-slip start. Sold per pair. 6 lbs.

F. HFT - Foam Training Hurdle.

Made of 18 oz. vinyl coated nylon. Adjustable heights; 30", 33", 36", 39". Double Velcro® strips hold heights in place. 13 lbs.

G. DISTANCE MARKER - Set of 12 Markers.

4" diameter steel, chalkboard-green disk. Names and numbers are easy to remove and write again. Speed up meets by marking every throw.

H. TSBC - Starting Block Cart.

All steel construction. Holds 10 starting blocks. Large base tray to store spikes and accessories. 3" swivel rubber wheel casters.

I. HAA - Rocker w/Brace - All Aluminum.

aluminum hurdle meets National High School rules. 5-height adjustments: 30", 33", 36", 39" & 42". Features heavier aluminum cross-brace and quality 41" plastic gateboard. 23 lbs.

J. HSA - Rocker - Steel/Aluminum Combo.

Steel base and aluminum upright hurdle. Meets National High School rules. 5-height adjustments: 30", 33", 36", 39" & 42". 41" plastic gateboard. 24 lbs.

K. HHS - Elite Aluminum High School Hurdle.

Welded one-piece aluminum base. Features interlocking grooved bases for easy stacking. 5 - height adjustments: 30", 33", 36", 39" & 42". 41" PVC gateboard. Meets National High School rules. 23 lbs.

Hurdles. Custom printing of the School Name (one color) for no extra charge on 50 hurdles or more.

COLORS - Upright tubing on hurdles is available in Natural Aluminum, Navy, Orange, Maroon, Purple, Royal, Black, Scarlet, Green, Vegas Gold and Light Gold.

L. HTRAIN - FormFinder Hurdle forces hurdler to bring trail leg under ampit. Keeps arm movement close. Both cross braces are Velcro® attached for easy breakaway. **Includes hurdle base.** 34 lbs. in two cartons.

* No Free Freight and Non-Returnable on Track Hurdles.

Track - Crossbars, Toe Boards, Rings & Pennants

A. Pole Vault Practice Crossbar PVC



B. Elastic Foam Crossbar with carry bag EFC



C. High Jump Practice Crossbar HJC



D. Hip Numbers HH9



E. Super Duty Measuring Tapes & Cane TMT05 TMT1 TMT2 TMT3



F. Shot Put Toe Board FTB



G. Long Jump Take-Off Board TOB

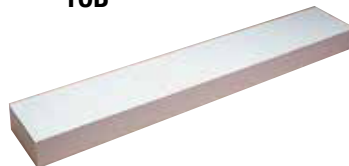

H. Shot Put & Discus Rings ASPC ADC



Meets IAAF, NCAA and NFHS Rules

I. Chute Penant Flags FLAGS



Pennant Post PP24 PP1

Practice Crossbars.

A. PVC- Pole Vault Crossbar. 14' 10". Extremely durable. Color: **Yellow**. Meets NFHS Specs. Freight only.

B. EFC - Elastic Foam Crossbar. For pole vault and high jump. Prevent injuries - no danger when hit. Bar does not fall due to contact or wind. Bright Fluorescent **Orange** cord. Includes mesh carry bag.

C. HJC - High Jump Crossbar. 13' 1-1/2". Extremely durable. Color: **Yellow**. Meets NFHS Specs. Freight only.

Hip Numbers.

D. HH9 - Photo finish makes these a necessity. 3-1/2" number on a pressure sensitive label that sticks to all uniforms. Set of 1-9 numbers (lanes). Sold in set of 25 of each number.

Super Duty Measuring Tapes.

E. Lightweight open reel design with quality fiberglass tape measuring in feet and meters. Quick retrieve folding crank.

TMT05 - 50'/15m. **TMT2** - 200'/60m.
TMT1 - 100'/30m. **TMT3** - 330'/100m.

CANE - Attaches to the end of measuring tape to tip of cane for fast and easy measuring.

Take-Off Boards.

F. FTB - Aluminum Toe Board. Molded fiberglass with extra impact resistance. Shaped to meet official rules. Weather-resistant. 9 lbs.

G. TOB - Long Jump & Triple Jump Take-Off Board. Black synthetic wood board is 48"x 8"x 2-1/2". Sealed, primed and finished in **White** outdoor enamel to resist weathering. Meets High School and NCAA specifications. 20 lbs.

Shot Put & Discus Rings.

H. ASPC - Aluminum Shot Put Ring. 1"x 3/4"x 1/4" aluminum angle. 3 sections. Measures 7' in diameter.

Compatible with any standard toe board. Meets IAAF, NCAA & NFHS rules.

ADC - Aluminum Discus Ring. 1"x 3/4"x 1/4" aluminum angle. 4 sections. Measures 8' 2-1/2" D. Meets IAAF, NCAA & NFHS rules.

Pennant Flags.

I. FLAGS - Multi-color chute rope and pennants. 120' length. Use for cross country course or for crowd control.

PP24 - 24-Pennant Posts for FLAGS. Pennant posts are molded and 48" L.

PP1 - 1 Pennant Post for FLAGS. Pennant post is molded and 48" L.

A. Electronic Starting Pistol Set

with portable amp, headset and carrying bag.
ESP



B. Starting Pistol Blanks AMMO



C. Long Range Megaphone ME3



25 Watt -
1,000 yd. range

D. Multi-Purpose Steel Equipment Wagon WAGON



E. Judges Stand STAND



F. Bulk Laces

Shoulder Pad



Pant

Shoe

54" Pink Shoe Laces

A. Electronic Starting Pistol Set.

ESP - Features include: three different starting tones: gun fire, beep and whistle; High visibility strobe light flashes with starting sound; Can simulate start Ultrak L10 Multi-lane timer; Compatible with FinishLynx; Powered by 3 AA batteries (not incl.); Connectable to portable amp; Amp can be used as a microphone or loud speaker; Amp has a maximum 20 watt output with volume control; Amp includes rechargeable lithium battery with 8 hours of use per charge. Carrying case and one-year warranty included.

B. Gator Starting Blanks.

AMMO - .32 Cal. provides most smoke, noise and flash. Black powder. Sold 50 per box.

C. Long Range Megaphone.

ME3 - 1,000 yard range. 25 watts. Adjustable volume control, powerful siren and shoulder strap. Takes 8 "C" batteries (not included).

D. Steel Equipment Wagon.

WAGON - Heavy-gauge, steel-mesh bed with fold-down sides. Bolts are welded to the bed for quick assembly. Pneumatic 13" wheels. 48" L x 24" W x 12" D. Capacity: 6.0 cu. ft. Weight limit: 1,000 lbs.

E. Judges Stand.

STAND - Seats 10-people or 20-people can stand. 5 rows of 48" long steps. Hand rail for top 3 levels. Rail support along the back for safety. Red enamel finish, with galvanized steel seats, headrests and back rests. Easy mobility provided by 8" wheels on back.

F. Bulk Laces - Loose laces per gross (144 each). Bulk pack (no packaging) sold per gross (72 pr.).

Shoe Laces - Polyester.

Flat - available in 7 colors.

LSP - 45" **WSP** - 63"

HSP - 54" **XSP** - 72"

Shoulder Pad Laces - Tough, round nylon end-tipped. Per gross.

SPL - 40" **White**. **SYL** - 32" **White** (Youth).

SPB - 40" **Black**. **SYB** - 32" **Black** (Youth).

Pant Laces - Round Nylon, end-tipped.

36" length, **15 colors**. Per gross or each.

FPL - Per Gross. **FPLE** - Per Each.

A. Basketball Nets

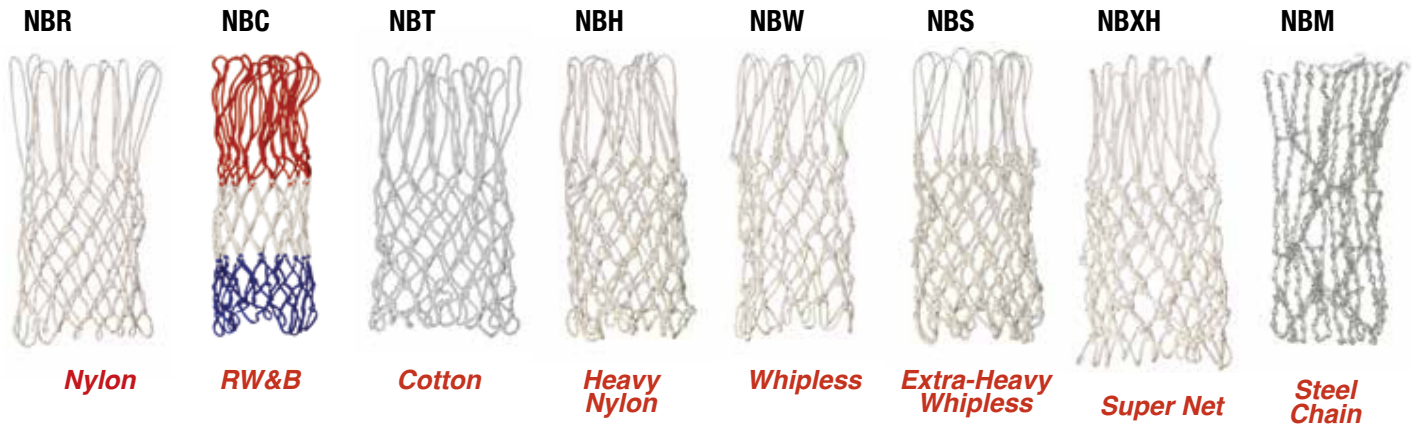

B. Heavy Duty Mesh Bag

MB12 Available in 4 colors.



Holds 12 Basket Balls

C. Strong Long Mesh Bag

MB5 Available in 4 colors.



D. Breakaway Goal & Net RIM



E. Basketball Bag

BKB Available in 5 colors.



Holds 6 Basketballs

F. ASI Clipboards



CBK

CBK2

G. "Heads Up" Dribble Glasses BDA



A. Basketball Nets. (Official Size)

All nets retailed packaged.

NBR - Regular **White** braided nylon.

NBC - **Red, White and Blue** as #NBR.

NBT - Soft **White** braided cotton.

NBH - Extra heavy weight **White** nylon.

NBW - Whipless - heavy braided nylon for anti-whip action.

NBS - Extra heavy duty, whipless braided nylon.

NBM - Steel chain net - zinc plated - "S" hooks attach to any style of goal.

NBXH - Super net. 33% heavier and stronger than our # NBH net.

B. Heavy Duty Mesh Bag.

MB12 - Holds up to 12 basketballs. 34" x 18" x 19" with full opening zipper.(3 rows of 4).

4 Colors: Black, Scarlet, Royal & Gold.

C. Strong Long Mesh Bag.

MB5 - Holds up to 5 basketballs. 38" x 10" with full opening zipper.

4 Colors: Black, Scarlet, Royal & Gold.

D. Breakaway Collegiate Rim & Net.

RIM - features an effective position lock mechanism to stand up to the rigors of power players dunk after dunk. **RIM** offers the ease of net installation with its no-tie net attachment. Due to its universal backplate, the **RIM** goal seamless fits on any size glass backboard.

E. Basketball Bag.

BKB - 18 oz. Vinyl with full zipper closure. Holds 6 basketballs.

5 Colors: Black, Scarlet, Navy, Royal and Kelly.

F. Basketball Clipboards. 9" x 15-1/2"

durable molded plastic clipboards with clear coating. Easily erasable with no residue. Tablet/papers clip on reverse side. Black marking pen included.

CBK - 9" x 15-1/2" durable molded plastic clipboards with clear coating. Easily erasable with no residue. Tablet/papers clip on reverse side. Black marking pen included.

CBK2 - 12" x 18" Basketball Clipboard. Same as all our other write-on plastic clipboards, only Bigger. This one measures 12" x 18".

G. Basketball Dribble Aid. Made in USA.

BDA - "Heads-Up" training aid glasses which block downward vision and teach the player to keep eyes on the field and not on ball.

Conforms to the face for comfortable fit.
BDAR - Above Poly-bagged with header.

A. Slipp-Nott™ Shoe Clean System

TRKR



TRK



TRK

B. High Speed School Pump

inflates basketball in seconds.

IPC



C. Welded Ball Cart

BRW2



Extra sturdy,
all welded
construction

D. Basketball Blocking Shield

BSC3



Colors: Black, Navy
Royal & Red

E. QB-TEE™ Quarterback Trainer



QBT
QBT-TIMER

F. Double-Wide 30-Ball Welded Cart

BRW30



H. Space Miser Ball Cage

SMBC



J. Ball Carry Net Bag

NBB



G. Portable Ball Carts



3 or 4 Rows

BR12
BR16

I. 15 Ball Cart

CART

A. "Trac Mate" Floor Wipes by Slipp-Nott™.

TRK - Basketball shoe cleaning system includes: **rubber bottom base mat holder** (24" x 17") and 2 sets of 30 ea. sheets of **replacement mats**. Trac Mate sheets remove dirt & build up from the bottom of athletic shoes. Eliminates hand wiping of shoe soles & affords greater traction and less slippage.
TRKR - "Trac Mate" Refill Mat.
1 set of 30 sheets.

B. Great School Pump.

IPC - 120 volt cord, on/off switch on unit, accurate gauge & accessory tips. Oversize power piston puts out a large volume of air to quickly inflate balls & other inflatables to 150 p.s.i. UL approved.

C. Welded 15 Ball Cart.

BRW2 - Extra heavy duty 1" square steel powder coated welded construction. 4 swivel, locking caster wheels. Holds 15 basketballs.
49"L x 16"W x 35"H. Ships UPS.

D. Basketball Blocking Shield.

BSC3 - Coaches use for aggressive post-up resistance. Players with their back to the basket meet this kind of aggression each game. Practice safe! 25" x 18" x 3" thick. 4 Colors: Black, Navy, Royal & Red.

E. QB-Tee™ Trainer.

QBT - Timing is everything! Allows the coach to measure timing, speed and quickness. When the player removes the ball from the cradle, the built-in timing clock is triggered. When the programmed time interval expires (i.e 3.4 seconds) the buzzer will sound. If the buzzer goes off before the player releases the ball, the play is dead. Great for timed drills. Features a built-in audible timing device, programmable timer, and two-position ball cradle.

QBT-TIMER - Replacement Timer.

F. Double-Wide Welded 30 Ball Cart.

BRW30 - Extra heavy duty 1" square steel powder coated welded construction. 4 swivel, locking caster wheels. Holds 30 balls.
52"L x 25"W x 35"H. Ships UPS.

G. Portable Ball Carts.

Heavy duty plated steel with thru-bolted bars and offset swivel casters.
BR12 - 12 ball cart.
BR16 - 16 ball cart.

H. Space Miser Ball Cage.

SMBC - Lockable vertical steel ball cage. Store and transport a multitude of balls using very little floor space. Non-marking swivel casters. Stores 28 basketballs or 32 Volleyballs. Red color.

I. 2 - Tier 15 Ball Cart.

CART - Holds 15 basketballs. 2-tier system for better strength and stability. Powder-coated ends with chrome ball support tubes and swivel caster wheels. 51" L x 19" W x 38" H.

J. Ball Carry Net Bag.

NBB - 4" braided nylon mesh w/draw cord. 24" x 36". White Only.

Jump Ropes

**A. Heavy-Duty Nylon
w/wood handles
JRH**



**B. Heavyweight Leather
JRL**



**C. Vinyl Speed Ropes
5 sizes
SR_**



**D. Plastic Segmented Ropes
5 sizes
JR_**



**E. Weight Lifting Belts
2-prong buckle
LB4 - 4" wide
LB6 - 6" wide**



**F. Ankle & Wrist Weights
AW5
WW2**



AW10

G. Shuttlecocks

BDSI - indoor



BDSO - outdoor

**H. Badminton Net
NBD**



**I. Badminton Racquet
BDR**



A. Jump Ropes.

JRH - Heavy Duty 8 1/2' Nylon Rope with wood ball-bearing handles.

B. JRL - 8 1/2' Leather Jump Rope with ball bearing handles.

C. Vinyl Speed Ropes.

Poly ropes with plastic swivel handles for speed jumping. Retail packaged.

SR7 - 7'

SR8 - 8'

SR9 - 9'

SR10 - 10'

SR16 - 16'

D. Plastic Segmented Link Jump Ropes.

JR7 - 7' Red/White

JR8 - 8' Blue/White

JR9 - 9' Yellow/White

JR10 - 10' Red/White/Blue

JR16 - 16' Red/White/Blue

E. Weight Lifting Belts. Two Prong Buckle.

Natural finish high quality cowhide.

4 sizes in both belts:

LB4 - 4" Wide.

LB6 - 6" Wide.

S (25" - 35")

M (31" - 41")

L (34" - 45")

XL (39" - 49")

F. Ankle and Wrist Weights.

AW10 - Two 5 lb. tough ankle weights have velcro closure. Boxed.

AW5 - Two 2 1/2 lb. ankle weights. Boxed.

WW2 - Two 1 lb. wrist weights. Boxed.

G. Shuttlecocks for Badminton.

BDSI - Nylon indoor tournament quality. 6/tube.

BDSO - Nylon outdoor tournament quality. 6/tube.

H. Badminton Net. 21' x 2 1/2'.

NBD - 1" polyethylene mesh, white nylon tape around top & edges, poly cable & tie down.

I. Badminton Racquet.

BDR - Lightweight tempered steel frame, durable nylon-coated steel strings and leather grip.

A. Official Lacrosse Goal and Net

LPG - frame & net
LRN - (replacement net)



D. Lacrosse Scorebooks

SBLW - women's
SBLM - men's



A. Official Size Lacrosse Goal & Net.

LPG - 6'H x 6'W x 7'D deluxe goal for your backyard or practice field. Heavy-duty 1.5" OD **Orange** powder coated steel tubing. Includes: 3.0mm **White** twisted polyethylene net, 30 Velcro® straps, and 4-U spike ground anchors. Sold per each.

LRN - Lacrosse Replacement Net.

3.0mm **White** twisted polyethylene net. 6' x 6' x 7'. Sold per each.

B. Deluxe Equipment Bags.

ST65 - 36" L x 18" W x 16" H. Heavy-duty polyester, water resistant fabric with a PVC backing. Rubberized bottom for added strength. U-shaped zippered opening. 2 end zippered pockets with interior zipped pockets. 45" handles for easy carrying. Padded hand grip.

7 Colors: Black, Navy, Royal, Scarlet, Dark Green, Maroon & Purple.

B. Deluxe Equipment Bag

7 Colors
ST65



Screen print available.



7 Colors:
Black, Navy, Royal, Scarlet,
Dk. Green, Maroon & Purple.

C. Lacrosse Pro Bounce Back Target LBBT



E. Lacrosse Clipboards

CBWL - women's
CBML - men's

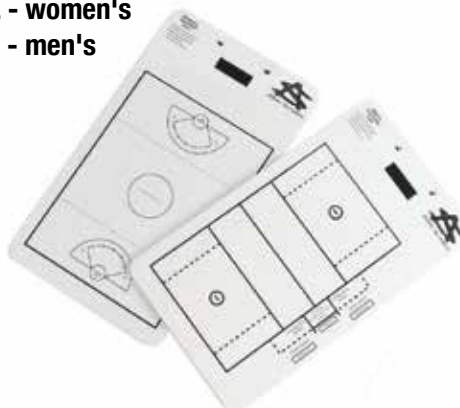

C. Lacrosse Pro Bounce Back Target.

LBBT - Adjustable powder coated steel frame for varied rebound angles. 4' x 3' rebound surface with dampener to absorb shock. 7' height.

D. Lacrosse Scorebooks.

SBLM - Lacrosse-Men's. 24 games, 33 players. Records penalties, face-offs, man up/man down, goalie saves and running score. Bigger in size: 9-1/4" x 12".

SBLW - Lacrosse-Women's. 24 games, 33 players. Records penalties, free position shots, draws, shots on goal, goalie saves and running score. Bigger in size: 9-1/4" x 12".

E. Lacrosse Write-On Plastic Clipboards.

9" x 15-1/2" very durable injection molded plastic clipboards with a baked on clear coating. Easily erasable with no residue. Tablet/papers clip on reverse side. **Black** marking pen included.

CBML - Lacrosse - Men.

CBWL - Lacrosse - Women.

CBML-R - Lacrosse - Men, **retail packaged.**

CBWL-R - Lacrosse - Women, **retail packaged.**

A. Adjustable Agility Ladder AAL



B. Economy Agility Ladder AAL27



D. Agility Rings AR11



E. Agility Spot Markers PS6



F. Step Hurdles SH6 SH12



G. Adjustable Hurdle Set AHS



I. Cleat Cleaners Made in USA

Travel
Cleat
Cleaner



TCC - 15" x 12"



LCC - 23" x 24"

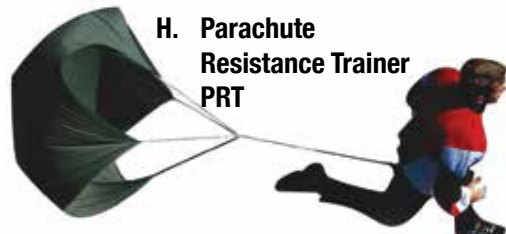

H. Parachute Resistance Trainer PRT

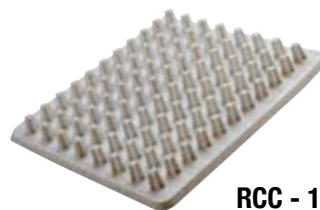

RCC - 12" x 11"

C. Power Sled Trainer PST



A. Adjustable Agility Ladder.

AAL - 30' length ladder with 21 adjustable flat rungs. The user can increase or decrease the distance between 2 rungs for different types of drills. Locking clips at end to join 2 or more ladders. *Includes carrying bag.*

B. Economy Agility Ladder.

AAL27 - Economy priced for all ages and skill levels. Comes in two sections that measures 27 feet when connected. Rungs are 16" wide and 16" apart. Includes carrying bag.

C. Power Sled Trainer.

PST - For power this is the one! Comes with adjustable resistance harness (fits small to XXL). Sled constructed of heavy galvanized steel. Will fit standard or olympic plates - weights not included. UPS. 38 lbs.

D. Agility Rings w/Mesh Bag.

AR11 - 11 multi-colored rings made of high impact PVC connected using velcro loops. Connect rings to create different footwork drills. Combine two or more sets to create more complex drills.

E. Agility Spot Markers.

PS6 - Durable, non-slip rubber spot markers. Granular top for great feel. Perfect for agility training. 9" diameter. Set of 6.

F. Step Hurdles.

Helps improve step quickness and agility. Position for plyometric jumps or running drills. Constructed of durable lightweight PVC tubing. Sold in sets of 6. 18" width.

SH6 - 6" H Step Hurdles.

SH12 - 12" H Step Hurdles.

G. Adjustable Hurdle Set.

AHS - Lightweight PVC hurdles are 23-1/2" wide with 3 height adjustments: 9", 12" and 14". Sold in set of 6.

H. Parachute Resistance Trainer.

PRT - Improves strength, speed, endurance & running form. Velcro belt releases chute quickly so athlete explodes forward and increases stride frequency. Chute has 60" diameter. Run straight ahead, sideways and backwards. 30 lbs. of resistance.

I. Cleat Cleaners. Made in USA.

TCC - Travel cleat cleaner with molded-in carrying handle. 15" x 12" with 88 tough rubber bristles to quickly remove debris from bottom of shoes. **Orange.**

LCC - Extra large size 23" x 24" square molded board with built-in carrying handle. 100 heavy-duty plastic pegs allow 2-3 players to use at same time. Easy clean up.

RCC - Heavy duty throw-down pad has 88 tough rubber bristles to quickly remove debris from bottom of shoes. 12" x 11". Has a hole on each corner for stake-down option. *Used by most Major League Baseball teams!*

**A. Deluxe Lockable Ball Cart
DBC**



*Hinged top
- can be
padlocked*

**B. Wire Mesh
Lockable Ball Cart
DBC2**



**C. 15 Ball Cart
CART**



**D. Welded Ball Cart
BRW2**



*Extra sturdy,
all welded
construction*

**E. Volleyball Drill Cart
VBC**



**F. Portable Ball Carts
BR12 - 3 row
BR16 - 4 row**



**G. Double-Wide 30-Ball
Welded Cart
BRW30**



**H. Space Miser
Ball Cart
SMBC**



A. Deluxe Lockable Ball Carts.

DBC - This sturdy ball cart measures 45" long x 24" wide x 38" high. Made of 1" powder-coated square steel tubing. Lockable hinged lid for security. 2 swivel caster wheels in front and 2 - 8" rear wheels for easy mobility. Holds 30 balls.

B. Wire Mesh Lockable Ball Carts.

DBC2 - This powder-coated steel wire mesh cart measures 42" long x 24" wide x 38.5" high. Hinged lid can be locked. 4 swivel caster wheels. Holds 30 balls.

C. 2 - Tier 15 Ball Cart.

CART - Holds 15 basketballs. 2-tier system for better strength and stability. Powder-coated ends with chrome ball support tubes and swivel caster wheels. 51" L x 19" W x 38" H.

D. Welded 15 Ball Cart.

BRW2 - Extra heavy duty 1" square steel powder coated welded construction. 4 swivel, locking caster wheels. Holds 15 balls. 49"L x 16"W x 35"H. Ships UPS.

E. Volleyball Drill Cart.

VBC - Measures 48" long, 22" wide, 12" deep, 40" high and holds up to 30 volleyballs. Constructed of heavy-duty black nylon on steel frame with swivel rollers for easy movement. Cart folds for easy storage and transportation. Includes black carrying bag.

F. Portable Ball Carts.

Heavy duty plated steel with thru-bolted bars and offset swivel casters.

BR12 - 12 ball cart.

BR16 - 16 ball cart.

G. Double-Wide Welded 30 Ball Cart.

BRW30 - Extra heavy duty 1" square steel powder coated welded construction. 4 swivel, locking caster wheels. Holds 30 balls. 52"L x 25"W x 35"H. Ships UPS.

H. Space Miser Ball Cage.

SMBC - Lockable vertical steel ball cage. Store and transport a multitude of balls using very little floor space. Non-marking swivel casters. Stores 28 basketballs or 32 Volleyballs. Red color.

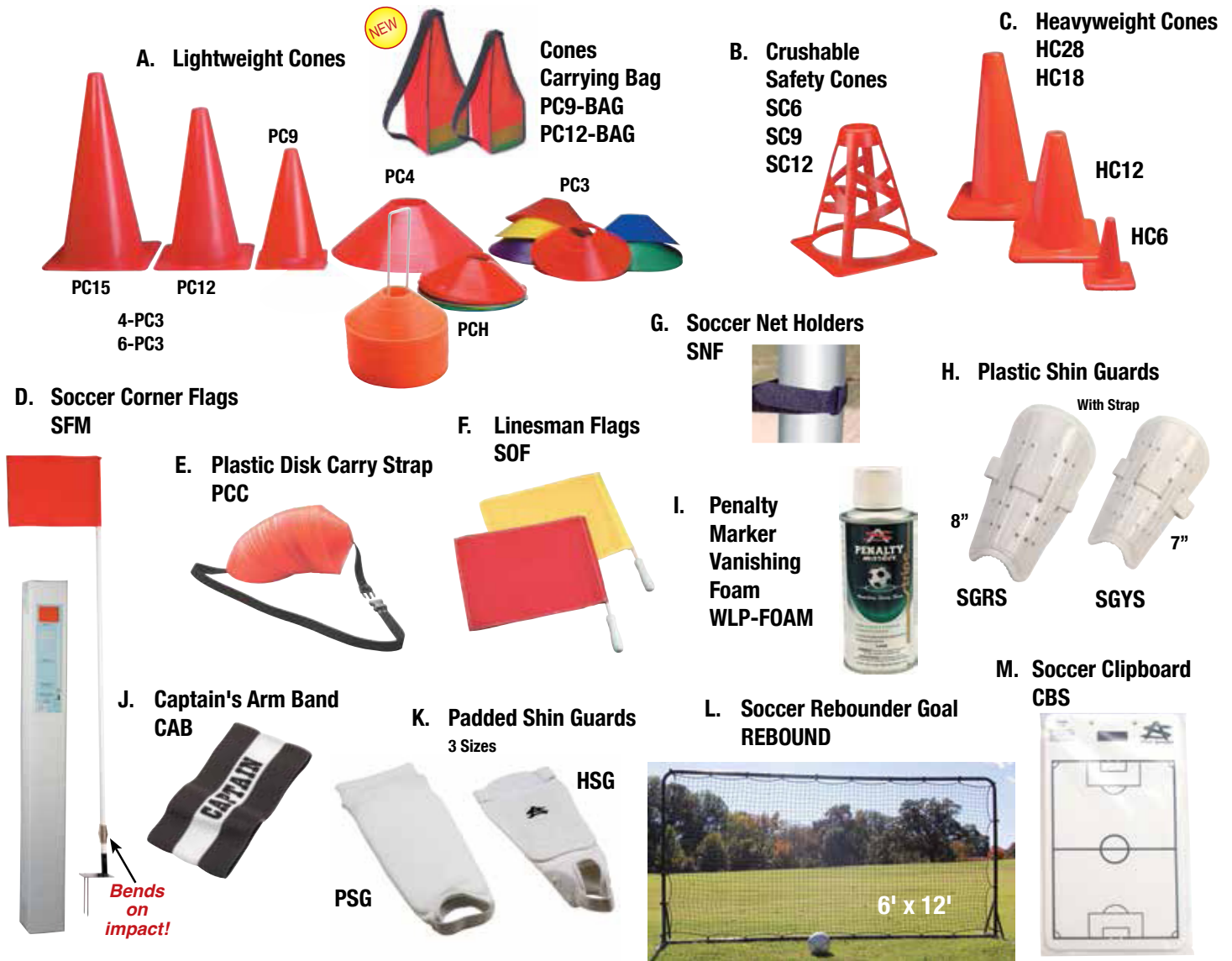

A. Lightweight Plastic Cones.

PC15 - 15" cone in **Fluorescent Orange**.
PC12 - 12" cone in **Fluorescent Orange**.
PC9 - 9" cone in **Fluorescent Orange**.
PC4 - 4" high open top cone (12" diam.) in 2 colors: **Fluorescent Orange & Yellow**.
PC3 - 2 1/2" open top cone (7 1/2" diam.) in **Orange, Yellow, Scarlet, Royal, Kelly, Purple**.
4-PC3 - Set of 4 **PC3** in orange.
6-PC3 - Set of 6 **PC3**. 1 ea. of **PC3** in 6 colors.

Cones Carrying Bag.

PC9-BAG - w/ shoulder strap. Holds 20 **PC9**.
PC12-BAG - w/ shoulder strap. Holds 20 **PC12**.

B. Safety Cones. Fluorescent Orange.

SC6 - 6" with cut outs for crushability.
SC9 - 9" with cut outs for crushability.
SC12 - 12" with cut outs for crushability.

C. Heavy Cones. Fluorescent Orange

extra durable open top cones. Weighted rubber bottoms yet cone remains soft & crushable.
HC6 - 6" height, 1 lb. weight.
HC12 - 12" height, 1 3/4lb. weight.
HC18 - 18" height, 3lb. weight.
HC28 - 28" height, 7lb. weight.

D. Soccer Corner Flags.

SFM - One piece **White** plastic pole with **Red** flag & offset "step on" spring mounted ground holder. Set of 4. Retail packaged.

E. Plastic Disc Cone Carriers.

PC3 - 60" Black poly strap holds up to 175 plastic disc cones. Carry over your shoulder.
PCH - Handy metal wire carrier for up to 200 disc cones.

F. Lineman's Flags.

SOF - One each **Scarlet & Yellow** with wood handles.

G. Soccer Net Holders.

SNF - Velcro fastener straps quickly secure nets to the goal frame. Fits up to 4" diameter frame. Per dozen pieces. **Black**.

H. Soccer Shin Guards for Youth Leagues.

Made with tough high-impact plastic construction and 3/16" inside comfort foam with vent holes. Adjustable Velcro® leg straps. Retail packaged.
SGRS - 8" size with adjustable straps.
SGYS - 7" size with adjustable straps.

I. Penalty Vanishing White Foam.

WLP-FOAM - See page 16.

J. Captain's Arm Band

CAB - Captain's arm band. One size. **Black**. Sold per 6.

K. Padded Shin Guards for Youth Leagues.

HSG - Removable plastic splints over comfort padding. Adjustable elastic, lightweight, open-back design with padded ankle guard. Machine washable. **White**. Sizes S, M, & L.
PSG - Full knitted elastic back with foot stirrups. 1/2" shock absorbing padding affords great protection with a secure fit. **White**. Sizes: S, M, & L.

L. Soccer Rebounder Goal.

REBOUND - 6' x 12' flat-faced goal. Galvanized steel tube frame with black net allows training on both sides of goal simultaneously. Includes 3' stabilizing legs for each side of frame, net, bungee cords for attachment and 4 ground stakes.

M. Soccer Clipboard.

CBS - 9" x 15-1/2" durable molded plastic clipboards with clear coating. Easily erasable with no residue. Tablet/papers clip on reverse side. Black marking pen included.

A. Canvas Equipment Bag
HEB



B. Deluxe Equipment Bag
TBL
TBM



C. Extra-Large Equipment Bag
XEB



D. Deluxe Equipment Bag
7 Colors *Screen print available.*
ST65



E. Large Equipment Bag
LEB

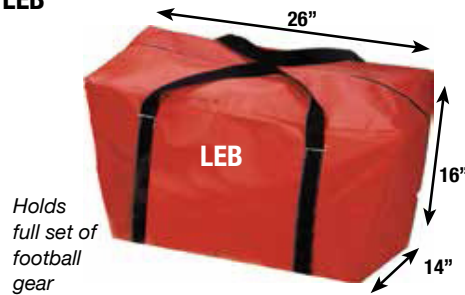

F. Heavy-Duty Mesh Bag
MRB



G. Football Bag
FBAG



H. Shoulder Strap



J. Ball Carry Net Bag
NBB



I. Identification Tag



A. Canvas Equipment Bag.

HEB - 36" L x 18" dia. **Black** canvas with 2" **Black** straps. Full zippered top.

B. Large Waterproof Nylon Bag.

TBL - 24" x 12" x 12" bag with 2 outside pockets and 1 inside security pocket.

3 Colors: Black, Scarlet & Pink.

Medium Waterproof Nylon Bag.

TBM - 21" x 12" x 9" Bag with 2 outside pockets and 1 inside security pocket.

1 Color: Black.

C. Extra-Long Equipment Bag.

XEB - 34"L x 15"W x 12"H. Easily holds over 3.5 cu.ft. Long enough for bats and wide enough for bases. Fill it up with catcher's gear or hockey & lacrosse equipment.

4 Colors: Black, Scarlet, Royal & Navy.

D. Deluxe Equipment Bag.

ST65 - 36" L x 18" W x 16" H. Heavy-duty polyester, water resistant fabric with a PVC backing. Rubberized bottom for added strength. U-shaped zippered opening. 2 end zippered pockets with interior zipped pockets. 45" handles for easy carrying. Padded hand grip.

7 Colors: Black, Scarlet, Royal, Navy, Maroon, Dk. Green & Purple.

E. Large Equipment Bag.

LEB - 26"L x 14"W x 16"H. Easily holds complete set of football gear. Large 3 cu.ft. for team catcher's gear or batting helmets & miscellaneous equipment.

4 Colors: Black, Scarlet, Royal & Navy.

F. See-Through Mesh Roll Bag.

MRB - 18"Length x 12"Height. Full opening zipper & black nylon bottom. Carry handles & D-rings on ends. **3 Colors: Black, Royal, & Red.**

G. Football Bag.

FBAG - Holds 12 footballs in 32" L x 24" W x 12" H bag. Uniquely constructed of 18 oz. waterproof coated vinyl with interior flap and Velcro closure for quick access to footballs during light rain. Interior dividers separate dry from wet footballs. U-shaped zippered opening with heavy duty 2" webbing wrap-around straps and end carry handles. **Black** only.

H Shoulder Strap.

STR - Adjustable 1 1/2" x 44" **Black** web shoulder strap with swivel snaps. Fits any bag.

I. Identification Tag.

TAG - Clear vinyl pouch with Velcro strap; attaches to any equipment.

J. Ball Carry Net Bag.

NBB - 4" braided nylon mesh w/draw cord. 24" x 36". White Only.

A. Laundry & Equipment Bags



B. Heavy-Duty Mesh Laundry Bags 4 Colors



C. Laundry Belts LBN2



D. Spirit Bags 5 colors



E. Strong Mesh Duffel Bag



G. Canvas Duffel Bags



F. 5" Laundry Pins LPIN



A. Laundry & Equipment Bags.

Mesh polyester bag with draw cord, sliding closure lock and write-on ID tag.

ELB2 - 15" x 22". **White** only.

ELB4 - 18" x 30". **White** only.

ELB6 - 24" x 36" in **7 Colors: White, Black, Scarlet, Royal, Gold, Dark Green & Navy.**

Fits 8 Soccer balls.

ELB6R - Retail packaging of ELB6 in poly bag with header.

B. Heavy Duty Mesh Bags.

REB6 - 24" x 36" extra strong nylon laundry/equipment bag with draw cord, lace lock & ID tag.

4 Colors: White, Black, Scarlet, & Royal.

REB4 - Same as above in 15" x 24" Size.

C. Laundry Belts.

LBN2 - Polypro belt with quick-release buckle and ID tag. Allows individual laundering of players clothing: jock, shirt, shorts, etc.

Does not include sock holder.

4 Colors: White, Black, Navy, & Scarlet.

D. Spirit Bags.

SBAG - Our heaviest weight mesh laundry/equipment bag with draw cord, sliding closure lock and write-on ID tag. *Suitable for screen printing.* 24" x 36" in **5 Colors:**

White, Black, Scarlet, Royal and Navy.

E. Strong Nylon Mesh Duffel Bag with Solid Black Nylon Bottom.

PDM - 28" wide x 40" long. Open mesh allows observation of contents and affords ventilation for drying. Shoulder strap, draw cord and lace lock. **6 Colors: White, Black, Scarlet, Royal, Gold, & Green.**

F. 5" Laundry Pin.

LPIN - 5" laundry pin made of steel and pre-numbered. Random numbers shipped 1-200.

G. Canvas Duffel Bags.

PDB - Extra Wide Canvas Duffel Bag. 24" x 42" with draw cord, lace lock & with double-stitched, reinforced color vinyl bottom. Inside pocket and shoulder strap. Holds set of football equipment and baseball gear. **Natural** canvas only. Bottom Colors: Black, Red, Royal & Navy.

SDB - Economy Natural Canvas Bag.

10 oz. lightweight bag is 22" x 34" with shoulder strap, draw cord & lace lock.

A. Heavy Duty School Inflator IPC



B. 120V Electric Inflator IPS



C. Bench/Table Top Pump IPB



D. Flat Proof Ball Sealant FPRO



E. 10" Hand Inflator IPH



Retail Pkg.



F. Double Action Hand Pump IP2



Retail Pkg.



G. Helmet Pump IPR

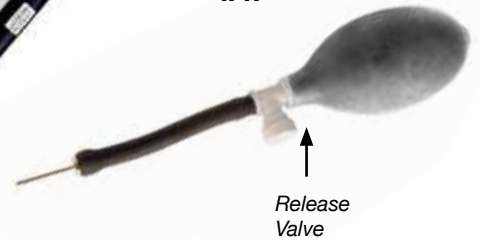

Release Valve

H. Pressure Gauges



BPL



BPR

I. Needles



INF (1-1/4")



INH (3/4")



IN3 (1-1/4")

J. Lubricant GLY



A. Deluxe Inflator. Great School Pump.

IPC - 120 volt, on/off switch, accurate gauge & accessory tips. 8' Cord. Oversize power piston puts out a large volume of air to quickly inflate balls & other inflatables to 150 p.s.i. UL approved.

B. 120 Volt Electric Inflator.

IPS - 1/8 HP Oil-less air compressor. Motor contained in high-impact plastic housing with built-in handle. 60 p.s.i. gauge. Coiled air hose extends 30".

C. Bench/Table Top Pump.

IPB - All steel construction, 3" diameter piston with 5" stroke, 9" handle & 18" hose with gauge.

D. Flat Proof Ball Sealant.

Seals/coats inside of ball to close all leaks and punctures in all inflated balls.
FPRO - 1 oz. tube with injection tip.

E. 10" Hand Inflator.

IPH - Lightweight and portable. Needle included. Retail packaged.

F. Double Action Hand Pump.

IP2 - Special valve allows inflation on both "push & pull" strokes. Retail blister packaged.

G. Helmet/Ball Pump.

IPR - Bulb pump with push button quick release air valve & 9/16" needle.

H. Pressure Gauge.

BPL - Pencil stick type needle inflation pressure gauge.
BPR - Round dial-type ball pressure gauge and deflator - blister carded.

I. Needles.

INF - Top quality Long 1-1/4" barrel inflating needles. Nickel plated steel. Sold per bag of 100.
INH - Short 3/4" inflating needles. Sold per bag of 12. Popular for helmets.
IN3 - 3 INF Long Barrel Inflating Needles. Retail blister packaged.

J. GLY - Glycerine Lubricant for needles. 1 oz.

Whistles & Lanyards

A. ACME® Whistles



ACME
Thunderer 660
W660



ACME
Finger 447/660
W660F



ACME
Thunderer 605
W605

Breakaway Lanyard LAWAY



LANR
*Retail
Pkg.*

B. Lanyards 9 Colors LAN



C. ASI Whistles



WS2



WSB



WSB-PINK

WMC



WMC R

D. Retail Packaged ASI Whistles



WS2R



WLC



WLTX



PLC

E. Wrist Lanyard LWN



F. Fox 40® Whistles



WF40C



WF40F



WF40P



WF40C-PINK



WF40C-MG



WF40M-MG

Cushioned Mouth Grip Whistles

A. Acme® Whistles.

Sold per dozen. Retail packaged.

W660 - Acme #660 Thunderer. **Black** plastic small whistle, tapered mouthpiece, high pitch, very easily blown.

W660F - As above #W660 with adjustable metal finger grip & **Black** cushion grips.

W605 - Acme #605 Thunderer. Nickel plated brass whistle, tapered mouthpiece, high pitch. Excellent ref's whistle.

B. Lanyards.

LAN - Braided nylon with metal swivel clips. One dozen per card.

9 Colors: *Black, Red, White, Navy, Gold, Green, Royal, Assorted Colors & Pink.*

LANR - LAN in retail blister pkg. Black only.

LAWAY - Breakaway lanyards. 1/2" wide with extra sturdy swivel clips. Will release from neck when tension is applied. **Black** only. Sold per dozen.

C. ASI Whistles.

WS2 - Top quality **nickel-free, unleaded Brass** Whistle. Heavy gauge with tapered mouthpiece, high pitch. Sold per dozen.

WSB - Top quality **Black** Plastic Whistle with tapered mouthpiece. Sold per dozen.

WSB-PINK - Top quality **Pink** Plastic Whistle with tapered mouthpiece. Sold per dozen.

WMC - **White** rubber whistle tip cover protects lips & teeth. Per dozen.

WMC R - WMC in retail package. Per each.

D. Retail Packaged Whistles.

WS2R - WS2 in retail package.

WLTX - Quality **brass** whistle, **Black** neck lanyard and mouthpiece cover. Retail blister carded & bar coded.

WLC - Small **Brass** whistle (WS2) with **Black** neck lanyard. Blister carded.

PLC - Small plastic whistle (WSB) with **Black** neck lanyard. Blister carded.

E. Wrist Lanyard.

LWN - Wrist & Shirt Short Lanyard of braided nylon with 2 clips. **Black only**. Sold per dozen.

F. Fox 40® Whistles.

Sold per dozen. Retail packaged.

WF40C - Full size original "classic" sonic **Black** plastic whistle.

WF40C-PINK - Full size original "classic" sonic **Pink** plastic whistle.

WF40C-MG - The original "classic" with a cushioned mouth guard ("MG"). Better grip, better control.

WF40F - Full size with cushioned finger grip.

WF40M-MG - The "mini" with a cushioned mouth guard ("MG"). Better grip, better control.

WF40P - Economical **Black** plastic "pearl" sonic all purpose whistle.

A. Scoremaster Scorebooks



C. ASI Molded Plastic Clipboards



Write-on Clipboards

B. Football Statistics Book SBF



D. ASI Scorebooks

FREE custom printing available, 200 scorebook minimum.



A. Scoremaster Scorebooks.

MARK5 - Mark V[®] Basketball. Top selling basketball scorebook in the world. Comprehensive, easy to use, & highest quality. The standard for all levels of competition since 1966. 15 players, 30 games. Wire bound.

SMK - Hi-Speed Scoremaster Basketball. Only 5-1/2" x 11" (closed). A complete record of game and player. 14 players, 33 games. Spiral bound at top.

SMOB - Original Scoremaster Baseball/Softball. Simplified, detailed history of each game. 11 batters, 12 innings, 25 games. *Includes pitch count.* Wire bound.

SM16 - Super 16 Scoremaster Baseball/Softball. Same as original scoremaster, but w/lineup cards, batting & fielding average chart, & team roster page. 16 batters, 10 innings, 26 games. Wire bound. *Includes pitch count.*

B. Football Statistics Book.

SBF - 12 game book keeps a detailed, easy-to-read account of every play. Record offensive possessions, defensive stats, kicks, returns, turnovers & penalties. Post-game & individual stats. End of season summary. 156 pages.

C. Write-On Plastic Clipboards.

9" x 15-1/2" durable molded plastic clipboards with clear coating. Easily erasable with no residue. Tablet/papers clip on reverse side. Black marking pen included.

- CBF** - Football - Scrimmage Line/Single Play.
- CBF-R** - CBF in *Retail package.*
- CBFF** - Football - Field.
- CBS** - Soccer - Field.
- CBS-R** - CBS in *Retail package.*
- CBK** - Basketball - Court.
- CBK-R** - CBK in *Retail package.*
- CBK2** - 12" x 18" Basketball.
- CBH** - Hockey - Rink.
- CBV** - Volleyball - Court.
- CBV-R** - CBV in *Retail package.*
- CBB** - Baseball - Lineup.
- CBBF** - Baseball - Field.
- CBBFL** - Baseball - Combo Field & Lineup.
- CBBFL-R** - CBBFL in *Retail package.*
- CBML** - Lacrosse - Men.
- CBML-R** - CBML in *Retail package.*
- CBWL** - Lacrosse - Women.
- CBWL-R** - CBWL in *Retail package.*
- CBPL** - Plain *White.*
- CBPO** - Pens only, dry erase. **Black**

D. Athletic Specialties Scorebooks.

SBS - Soccer. 24 games and charts for schedules, squad members & main scoring section.

SBK - Basketball. 30 games, 15 players, season schedule and charts, running score with individual stats.

SBV - Volleyball. 23 games, spaces for 18 substitutions. Summary, stats and rally scoring.

SBB - Baseball/Softball. 25 games, 18 player spaces. Popular for Little League. Summary chart and batting averages. *Includes pitch count.*

SBB2 - Large Side-By-Side Baseball/Softball. Score both teams on same page. 50 games, 15 players. *Includes pitch count.* Team roster. Very detailed. 14" x 11-1/4".

SBB2 - Detailed Baseball/Softball. 25 games, 11 players, larger scoring boxes w/summary chart & batting avgs.

SBT - Track. 19 meets, 14 events, 3 relays and stats.

SBLM - Lacrosse-Men's. 24 games, 33 players. Records penalties, face-offs, man up/man down, goalie saves and running score. Bigger in size: 9-1/4" x 12".

SBLW - Lacrosse-Women's. 24 games, 33 players. Records penalties, free position shots, draws, shots on goal, goalie saves & running score. Bigger in size: 9-1/4" x 12".

SBW - Wrestling. Complete scoring information columns. 17 weight classes, dual scoring, 8-man, 16-man and 16-man double elimination tournament brackets, team summaries.

Stadium Chairs, Scoreboards, Rubber Animals & Display Cases

A. Stadium Seat GCSC



B. Carry Bag for Stadium Chair SCBAG



C. Stadium Seat Cushions SSC



D. All Sports Possession Arrow ARROW



E. Multi-Sport Tabletop Scoreboard SCORE



F. Flip-A-Scorers



G. Display Cases



new
pic
coming



I. Supporters & Cups

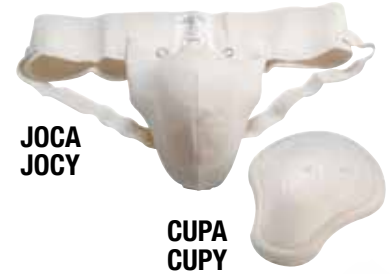

A. GameChanger™ Stadium Chair.

GCSC - These chairs include patented bungee-cord cushioning, and added hinged back for more comfortable lower back support as well a durable black steel frame & tough Cordura canvas. Open size: 13.5" D x 17" W x 16" H.
4 Colors: *Black, Red, Navy & Royal.*

B. Carry Bag for Stadium Chair.

4 Colors: Black, Red, Navy & Royal.
SCBAG - 600 denier polyester. Front pocket.

C. Stadium Seat Cushions.

SSC - Great fund-raiser! 10 oz. vinyl cushion with 1-1/2" padding and reinforced handle. Double-stitched seams.
Size: 14-1/4" x 14-1/4" x 1-1/2".
9 Colors: *Red, Royal, Forest Green, Gray, Yellow, Black, White, Navy and "Two-Toned"* (any 2 colors on either side).

D. All Sports Possession Arrow.

ARROW - Bright LED display features indicator lights to view easily. Size: 21"W x 6"H x 3"D.

E. Electric Portable Scoreboard w/Remote.

SCORE - Features clock, stopwatch & timer program with alarm, and built-in carry handle. Bright LED lights. Clock numbers 5" high & Score numbers 4" high. Scores up to 199. Time counts up or down to 99:59 minutes and 1/10th of a second timing in last minute. Includes period, bonus and foul indicators. 15ft power cord. Size: 24"L x 10"D x 16"H.

F. "Flip-A-Scorer" Table Scorer.

FAS - Highly visible 5 1/2" numbers. Scores two teams up to 99.
FAS2 - Deluxe Portable Scorer. A solid long lasting flip scorer with big 9.5" vinyl numbers on a 24" x 12" heavy plastic board. Scores 0-99 with a 5 period indicator. Folds flat for storage and comes with built-in handle strap.

G. Display Cases.

High Quality Clear Acrylic - Made in USA. Packaging includes an image of "grass turf" or "hardwood floor" to be used inside cube.
BDC - Baseball. Sold per case of 24.
BDCW - Baseball w/solid wood base. Sold per case of 6.
FDC - Football. Sold per each.
FMDC - Mini football helmet. Fits both Schutt® and Riddell® mini helmets. Sold per each.
BSDC - Basketball/soccer. Sold per each.

H. Athletic Supporters and Cups.

Soft & comfortable supporter with 3" waistband & non-curl straps. Includes protective soft edge cup. Retail packaged.
JOCA - Adult size. 4 Sizes: S (26-30), M (32-36), L (38-42) & XL (44-48).
JOCY - Youth size. 3 Sizes: S (20-24), L (26-30) & XL (32-36).
CUPA - Adult size flexi-firm cup with soft edge in poly bag.
CUPY - Youth size flexi-firm cup with soft edge in poly bag.

A. 5-Yard Elastic Wraps



B. Eye Protector EP2



C. Leader® Swim Goggles



D. Trainer's Tape 32 per Case ATAPE



F. 60-Piece First Aid Kit FAK2



G. 22-Piece First Aid Kit FAK1

Team First Aid Kits



H. ASI Hat HAT



ATAPE-PK Hot Pink Color

E. Foam Underwrap 12 per Case UWRAP



I. Protective Nose Guard NP1 NP2



16 per Case 7" x 5"

J. Instant Cold Packs ICP ICP2

NEW



16 per Case 9" x 6"

K. Hot Packs HOT2



40 per case

30 per case

L. Reuseable Hot-Kold Gel Pak HOKO

12 per case



A. Elastic Wraps. Economical polyester knit latex-free wraps are individually shrink wrapped with clamps. All widths are *Beige*, stretch to 5 yds. and afford excellent compression. Sold per dozen per width. **EW3** - 3" width. **EW4** - 4" width. **EW6** - 6" width.

B. Leader® Eye Protector.

EP2 - Eye protector for racquet sports, basketball or wherever eye protection is needed. Optically correct shatterproof lens allows wide peripheral vision and are anti-fog treated. Display boxed. One size.

C. Leader® Swim Goggles.

SWMA - A good general purpose Adult swim goggle with adjustable flat eye piece. Retail pkg. *Clear*.
SWMY - As above in Youth size. *Clear*.

D. Trainers Tape.

ATAPE - PolyCotton tape provides high tensile strength and conformability. Hand tearable and rips length wise. Computerized unwind tension. Unbleached cloth. 1 1/2" x 15 yard rolls. Sold per case of 32 rolls.

ATAPE-PK - *Hot Pink* PolyCotton tape provides high tensile strength and conformability. Hand tearable and rips length wise. 1-1/2" x 10 yard rolls. Sold per case of 32 rolls.

E. Foam Underwrap.

UWRAP - A thin foam substrate that is strong and highly porous. Used under trainers tape for comfort and painless tape removal. 2-3/4" x 30 yards. Sold per case of 12 rolls. *Color: Natural*.

F. 60 Piece First Aid Kit.

FAK2 - In heavy duty plastic box with handle. Bandages, pads, ointments, wipes, tools, tape & first aid guide. A basic entry kit for general small team sports use.

G. 22 Piece First Aid Kit .

FAK1 - Plastic box includes bandages, pads, ointments, wipes & tape. A must for every car.

H. Baseball Hat.

HAT - *Athletic Specialties Hat*. It's the hat everybody is asking for. Worn by HOF athletes to rock stars!! Place an order over \$100 and the hat is yours. *FREE. Thank You for Your Past Support. You must order Hat for us to ship.*

I. Protective Nose Guard.

NP1 - High-impact protective nose guard. Rigid plastic and soft padding with adjustable strap.
NP2 - Same as NP1, but for larger faces.

J. Instant Cold Packs.

ICP - Activates instantly when squeezed. Needs no refrigeration. Remains cold approximately 30 minutes. 7" x 5". Sold per case of 16
ICP2 - 9" x 6". Sold per case of 16

K. Hot Packs.

HOT4 - 12 hour single hot pack. Sold per each.
HOT2 - 7 hour double hot pack. Sold per each.

L. Reuseable Hot-Kold Gel Pak.

HOKO - For hot and cold therapy. Maintains an even temperature. 7" x 5". Sold per case of 12.



ATHLETIC SPECIALTIES

i n c o r p o r a t e d

FROM THE PEE WEE LEAGUES TO THE PROS®

asisports.com



ORDERS:
P: 800-779-0990
F: 800-493-2565
ann@asisports.com



Limited Warranty: Athletic Specialties, Inc. warrants any goods normally produced by it, and offered for sale at a published list price, to be free from defects in materials and workmanship at the time of shipment for a period of 6 months from shipping date of such merchandise. Ordinary wear and tear excluded.

Statement of Policy: The user assumes all risks entailed in action since ASI cannot guarantee freedom from injury. Use of this equipment cannot prevent serious injury or death. Sporting events are dangerous in nature and the participant assumes all risk therein. Certain pieces of protective equipment are designed to reduce the possibility of injury to the specific body part which it covers. Use of this equipment does not guarantee you will be protected from serious, disabling, or permanent injury while playing football, baseball or any other sports. It is the Dealer/Distributor's responsibility to pass this information to the consumer. All equipment is sold on this condition and by no means can any company representative waive or alter this position. A.S.I. shall not be held liable for damages arising from failure to make delivery on all or any part of any order caused by fire, flood, strikes, riots, inability to obtain supplies and materials, act of God, or any circumstances or accident beyond its control.

How Paint May Affect Grass: Please be informed that any paint coating may have adverse effects on grass. Adverse effects will be temporary. Grass will lose its green color and will appear dead. This is due to the fact that the paint coating covers the grass foliage entirely, thus preventing the foliage from getting the much needed energy from the sun and moisture from the atmosphere, in order to sustain its green color. This damage to grass is not permanent, since the roots are not affected. Grass will grow back to its green color as new growth appears.

WARNING: ASI advises that football protective equipment is designed to help reduce the possibility of head concussion or injury to the specific body part which they cover. Use of any equipment does not prevent concussions and the user is not protected from serious, disabling or permanent injury while playing football.

WARNING: ASI advises that sliding into a baseball base represents a clear and present danger. Injuries may occur.